

i am
your
favourite



Gas fires 2024

i am  since 1754

The fire specialists since 1754

What could be cosier than a burning hearth fire? Whether you prefer a classic or a sleek design, at DRU you will find your ideal gas fire. Thanks to our knowledge and expertise – we have nigh on 270 years' experience when it comes to providing comfortable, sustainable, safe heat in the home – we will always offer the best solution for you. Our innovative craftsmanship is in evidence in each and every model in our series of modern gas fires, all of which satisfy extremely strict requirements in terms of sustainability, efficiency, emissions, safety and ease of use. After all, we keep improving, each and every year. If you want to heat your home in style, choose DRU.



Scan the QR code and watch the DRU corporate video



Balance between people and their surroundings

At DRU, customer satisfaction and efficiency go hand in hand with safety and environmental friendliness.



Premium-quality ambition

We do what we say and say what we do. We are ambitious and critical and continuously improve ourselves.



The convenience that makes the difference

Convenience for the end user is always key. Our focus: working on smart, innovative, comfortable products.



Continuous development

We are curious, keen to learn and forward-thinking. Progress only comes from continuous development.



See our fires burning

Scan the QR codes next to the fires and see them in action.

i am consciously comfortable

Ultimate heat, atmosphere and convenience? That's what I offer you. Install me wherever you want and I'll provide the most beautiful fire. I can be operated from the comfort of your sofa and no wood is required. Entirely safe, clean and simple, then. And did you know I'm future-proof too?

I'm a sustainable alternative when used with biogas or biopropane. In short, I offer you nothing but benefits and

I'm sure I'll be the perfect addition to your home!

contents

About DRU

Lifestyle	4
Environment and consumption	6
Interior and wall panels	8
Innovations	10
Gas and sustainability	12

DRU fires

Maestro fires	14
Metro fires	34
Lugo fires	50
Cosmo fires	54
Paco fires	58
Free-standing and suspended fires	62

DRU Global fires

<i>Open combustion (CF)</i>	
Global fires	72
<i>Closed combustion (BF)</i>	
Global fires	72

Technical details

Installation options	84
Frames	86
Control and accessories	88
Line drawings	90
Technical specifications	96

how will I fit in with your life?

I'd be a great choice for your living room. After all, you want atmosphere and cosiness at home as well as warmth and comfort. I come in all shapes and sizes. Discover the best way to integrate me into your home here!



Stylish and warm

Keen to find a new fire to heat your home or is atmosphere your priority? What you are ultimately looking for will decide the first step towards finding your new fire.



Design for all

Do you prefer a classic design or sleek and modern? At DRU, you will find fires for every taste and every space. From built-in to free-standing fires, from front fires to 3-sided fires or even a tunnel model. The choice is yours!

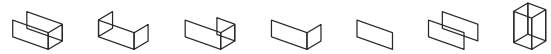

Our range of fires



Space and output

The gas fire's ideal output will depend on the space in which it is to be installed, how well your house is insulated and the fire usage: do you switch it on every day or just during the weekend, for instance? Thus ensuring you always choose the most sustainable solution for your home.

Get inspired

At an authorised DRU dealer in your area you can get tailored advice and take a closer look at our models. This way, you can make a well-considered choice for a fire you'll enjoy for years to come.

bespoke atmosphere and heat

Less consumption, less heat, without compromising on atmosphere. Sounds great, right? I'm Eco Wave and I'll take care of it for you! Actually, we'll do it together, as you can control consumption and the flames. With my help, you'll be able to enjoy realistic flames in your stylish fire all year round.

Efficient, elegant and easy to use.



Eco Wave

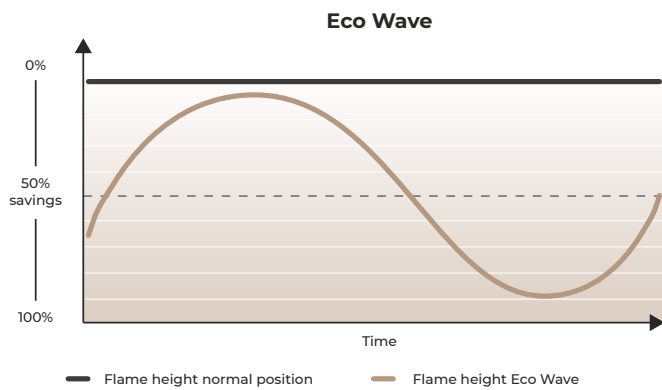

Control over your energy

Our unique Eco Wave technology in the gas fire burners will reduce your gas consumption by up to 50% without affecting the atmosphere in your home, thus enabling you to enjoy a stunning flame picture all year round *and* have full control over your consumption. Controlling the heat, flames and consumption is very simple using the DRU Fire app or DRU remote control. There is a choice of two different standby modes or you can even develop your own standby mode, making it very sustainable!

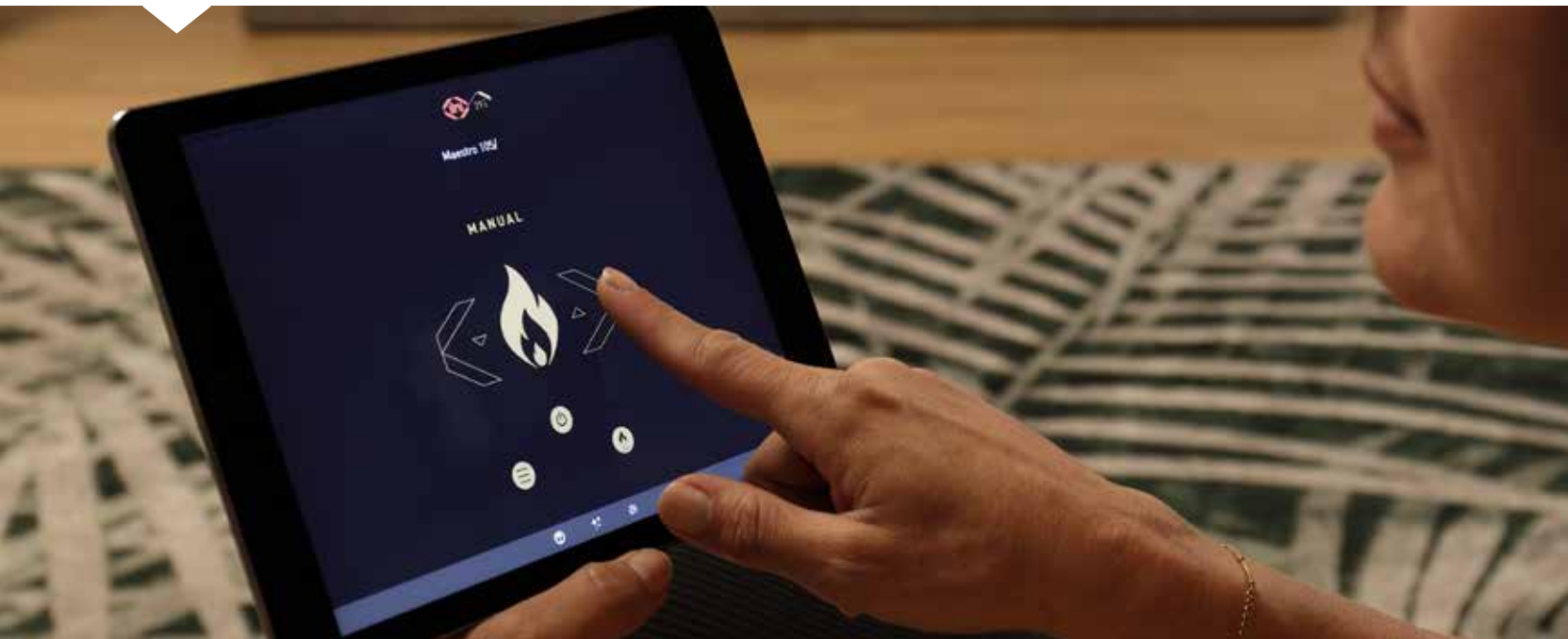

Eco Glow

100% atmosphere, 0% heat

Prefer to drop the heat and keep the atmosphere?
Then switch to the Eco Glow function. Eco Glow enables you to enjoy a glowing fire thanks to its LED burner bed. This realistic burner bed does not give off any heat and can be controlled separately. This means you will be able to control the atmosphere in your home using the DRU Fire app or remote control.



a unique look

Everyone has their own tastes. And a good thing too, because endless combinations are possible with me. Would you prefer a black, sleek internal lining or a more robust look? And what do you want the wall panels to look like? At DRU, you can choose your own design, right down to the tiniest details.

Choose your own design

You can choose the internal lining* of pretty much all of our gas fires yourself. 6 different designs are available: black, ceraglass, matt glass, rib cast, classic stone (DRU) and classic stone (DRU Global). Each design does something different to the inside of your fire. Black is sleek and is ideal in a modern living room. Ceraglass has a beautiful mirror effect, creating extra depth in the fire. Rib cast is our most robust internal lining. Last but not least, you can choose from 2 types of classic stone, each with a classic look.

** Available on some models.*



Black



Ceraglass

Matt glass

Rib cast

Classic stone (DRU)

Classic stone (DRU Global)



Complete your fire with wall panels

You can also choose the look of the exterior of the fire yourself. Our rib cast wall panels* will make your fire interior even better. The wall panels are about 30 cm wide. The height depends on the type of fire and is fully tailored to that.

** Available on some models.*





Read more on
Clear View glass
Scan the QR code.



Clear View glass

perfect view

The perfect view of my flames obviously depends on the quality of the glass used. Would you prefer anti-reflective glass or not?

And how should you keep that clean? Fortunately, our manufacturers have thought of everything to enable you to enjoy me unhindered.

Ultra-clear view of the flames

Having a good view of the flames means extra enjoyment of your burning gas fire. Which is why at DRU you can choose Clear View glass*: anti-reflective glass providing an optimum view of the flames. This glass is ideal in rooms with little direct sunlight or in dark-coloured interiors.

** Available on pretty much all models in the range*



Easy release door system

clean in no time at all

A variety of our gas fires come with a handy drop-down door. Easy to open without force, ideal for quick cleaning of the glass panes and annual maintenance by an engineer.

- Can be opened directly without unscrewing or without tools or force
- Subtle, concealed door lock
- Invisible frames for more glass surface and unhindered view of the flames
- Seamless glass-on-glass in 2-sided and 3-sided models
- Closely sealed: safe, optimum burning



Read more on Easy release door system
Scan the QR code.

for every type of gas

My designers don't just look at the design when developing energy-efficient fires and heaters. They also ensure maximum flexibility. Which is why we can all run on various types of gas... making us suitable for any property!

What does it cost to run a DRU gas fire?

Calculating the consumption of a specific fireplace is very simple. You calculate the cost per evening, assuming 3 hours of burning on regular natural gas.

Know the cost within a minute with our gas consumption calculator.



Why should you still go for gas?

Gas has been a much-discussed fuel in recent years. Gas prices have been soaring due to all kinds of international developments.

And fewer and fewer (new-build) properties have any gas connection at all. But did you know that a gas fire is still a very sustainable, future-proof choice? Even if you don't have a gas connection, as is the case in several countries. We will be happy to highlight the benefits of a DRU gas fire.

Sustainable gas: (bio-) propane

DRU gas fires run on various types of gas. Natural gas, of course, but also all kinds of sustainable bottled gas, such as biogas (methane and propane). Biogas is released from waste, residues and plant oils, making it a sustainable type of gas and an environmentally friendly alternative to natural gas. Hence you will be using renewable energy and avoiding fossil fuels. In addition, DRU gas fires have already been prepared for a substantial hydrogen blend percentage.

Highly efficient

A gas fire is a highly efficient source of heat. You will only be heating the room you are in and not lots of other ones. What's more, DRU gas fires burn extremely efficiently. Nigh on all the heat produced (up to 90%) goes straight into the living room, meaning very little heat loss. And you will have full control over this heat. Keen to reduce the heat but keep the atmosphere? Then switch over to the unique functions that our gas fires boast, such as Eco Wave or Eco Glow. Now that's responsible enjoyment!

Ready for the future: hydrogen

You may well have a gas connection now but want to wean yourself off gas in the future. In which case, you can't go wrong with a DRU gas fire. Even after purchasing a fire, you will still have the option of switching over to a different type of gas, such as (bio)propane. Thus giving you control over whether or not you want to continue using natural gas as a source of heat. What's more, DRU gas fires are prepared for a hydrogen blend of up to 20%. If your gas network is ready, so are we!



All DRU gas fires come with the VBS system. This system ensures that, irrespective of the composition of various types of gas, your fire will always keep burning. Guaranteeing you heat and cosiness for many years to come!

This brochure only features images of gas fires that run on natural gas. Flame colour may vary when a fire is running on another type of gas.



i am maestro

I'm the most exclusive model within the DRU gas fire collection.

The fact that I come in various shapes and sizes means I'll suit practically any interior.

And thanks to my unique burner technology, you're always assured the most beautiful
fire with lively flames. What luxury!



3-sided XTU

75XTU *Eco Wave*



3-sided

60/3 *Eco Wave*
60/3 Tall *Eco Wave*
80/3 *Eco Wave*
105/3 *Eco Wave*



2-sided

60/2 *Eco Wave*
60/2 Tall *Eco Wave*
80/2 *Eco Wave*
105/2 *Eco Wave*



Front

60 *Eco Wave*
60 Tall *Eco Wave*
75 *Eco Wave*
75 Tall *Eco Wave*
100 *Eco Wave*



Tunnel

75 Tunnel *Eco Wave*
75 Tunnel Tall *Eco Wave*

flame



Dynamic Flame Burner®

Lively, natural flames built like a real log fire.

The double burners ensure extra height and depth in the fire.

control

Controlling your fire is really straightforward with the **remote control** that comes with me as standard



Also use our handy **free DRU Fire app** for full control over your fire.



Easy connection for control via your Home Domotica System.



Black

Matt glass

Ceraglass

Rib cast

Classic stone (DRU)

useful to know



Easy release door system

Easy release door system means you do not have to use any force when opening your fire. What's more, this handy drop-down door is ideal for cleaning your fire.



VBS

All DRU gas fires come with the VBS system. This system ensures that, irrespective of the composition of various types of gas, your fire will always keep burning. Not got a permanent natural gas connection? No problem. Our fires also work on butane, biogas or biopropane.



Direct flue

We will happily give you full freedom to install your fire wherever you want. You could (for example) have the extraction for your fire run through the façade. The extractor will connect straight up to the fire and run with a 90° bend to the exterior.

choose your look

Interior

Choose the internal lining that suits your interior.

Wall panels

Our rib cast wall panels will complete your fire's look.



Glass window

Choose our unique Clear View glass: anti-reflective glass providing an optimum view of the flames.

Burner bed

Maestro fires include a realistic log set in brown.



Log set brown



Frames

Our fires come with a frame as standard, but are also available with customised frames or frameless.



PowerVent®

PowerVent® is a plug & play concentric extraction system with fan. The flexibility of this extraction system makes it possible to install a gas fire in practically any situation.

sustainability



Eco Wave

Reduce your gas consumption by up to 50%, without affecting the atmosphere in your home.



Eco Glow

Prefer to get rid of the heat completely and yet keep the atmosphere? Then switch to the illuminated glow bed.



Maestro 75XTU *Eco Wave*

Characteristics:

- Luxury, elegant room divider
- Can also be suspended or built in semi-high



Output range

Natural gas G20	1.2 - 8.8 kW
Natural gas G25.3	1.2 - 8.4 kW
Propane G31	1.9 - 9.5 kW

Efficiency

93.3%

A





Scan this QR code
to see the fire burning.



Maestro 60/3 Eco Wave

Characteristics:

- Extremely beautiful with ceraglass interior
- Also suitable for smaller rooms

Choose your own size:

(see p. 90 for precise dimensions)

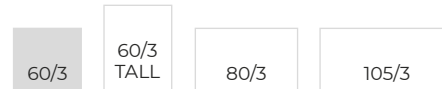

Output range		Efficiency						
Natural gas G20	1.9 - 7.2 kW	94.3%						
Natural gas G25.3	1.6 - 6.8 kW							
Propane G31	1.1 - 7.3 kW	A						



Scan this QR code to see the fire burning.



Scan this QR code to see the fire burning.



Maestro 60/3 Tall *Eco Wave*











Characteristics:

- Modern high glass pane
- Ample options available for luxury finish

Choose your own size:

(see p. 90 for precise dimensions)



<p>Output range</p> <p>Natural gas G20 1.9 - 7.2 kW</p> <p>Natural gas G25.3 1.6 - 6.8 kW</p> <p>Propane G31 1.1 - 7.3 kW</p>	<p>Efficiency</p> <p>96.3%</p> <p>A →</p>	<p>    </p> <p>    </p>
--	---	---



Maestro 80/3 *Eco Wave*

Characteristics:

- Unhindered view of the flames
- Wide output range

Choose your own size:

(see p. 90 for precise dimensions)



Output range

Natural gas G20	1.4 - 9.0 kW
Natural gas G25.3	1.3 - 8.6 kW
Propane G31	1.3 - 7.7 kW

Efficiency

93.0%

A





Scan this QR code to see the fire burning.



Scan this QR code to see the fire burning.



Maestro 105/3 Eco Wave

Characteristics:

- Natural full flames
- Sleek and can be built in frameless

Choose your own size:

(see p. 90 for precise dimensions)

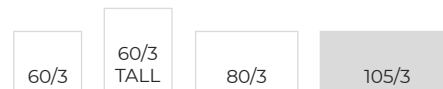

Output range

Natural gas G20	2.5 - 10.3 kW
Natural gas G25.3	2.1 - 9.8 kW
Propane G31	2.6 - 10.5 kW

Efficiency

91.2%

A →



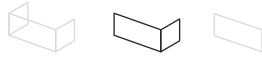

Maestro 60/2 Eco Wave

Characteristics:

- Beautiful corner fire for smaller rooms
- Extremely efficient

Choose your own size:

(see p. 90 for precise dimensions)

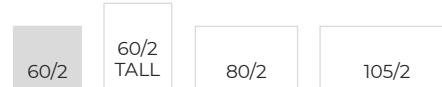

Output range

Natural gas G20	1.9 - 7.2 kW
Natural gas G25.3	1.6 - 6.8 kW
Propane G31	1.1 - 7.3 kW

Efficiency

94.3%

A



Scan this QR code
to see the fire burning.



Scan this QR code
to see the fire burning.



Maestro 60/2 Tall *Eco Wave*

Characteristics:

- Modern high window
- Also suitable for smaller rooms

Choose your own size:

(see p. 90 for precise dimensions)



Output range

Natural gas G20 **1.9 - 7.2 kW**
 Natural gas G25.3 **1.6 - 6.8 kW**
 Propane G31 **1.1 - 7.3 kW**

Efficiency

96.3%

A





Maestro 80/2 Eco Wave

Characteristics:

- Optimum fire experience
- Sleek and can be built in frameless

Choose your own size:

(see p. 90 for precise dimensions)



Output range		Efficiency				
Natural gas G20	1.4 - 9.0 kW	93.0%				
Natural gas G25.3	1.3 - 8.6 kW	A				
Propane G31	1.3 - 7.7 kW					

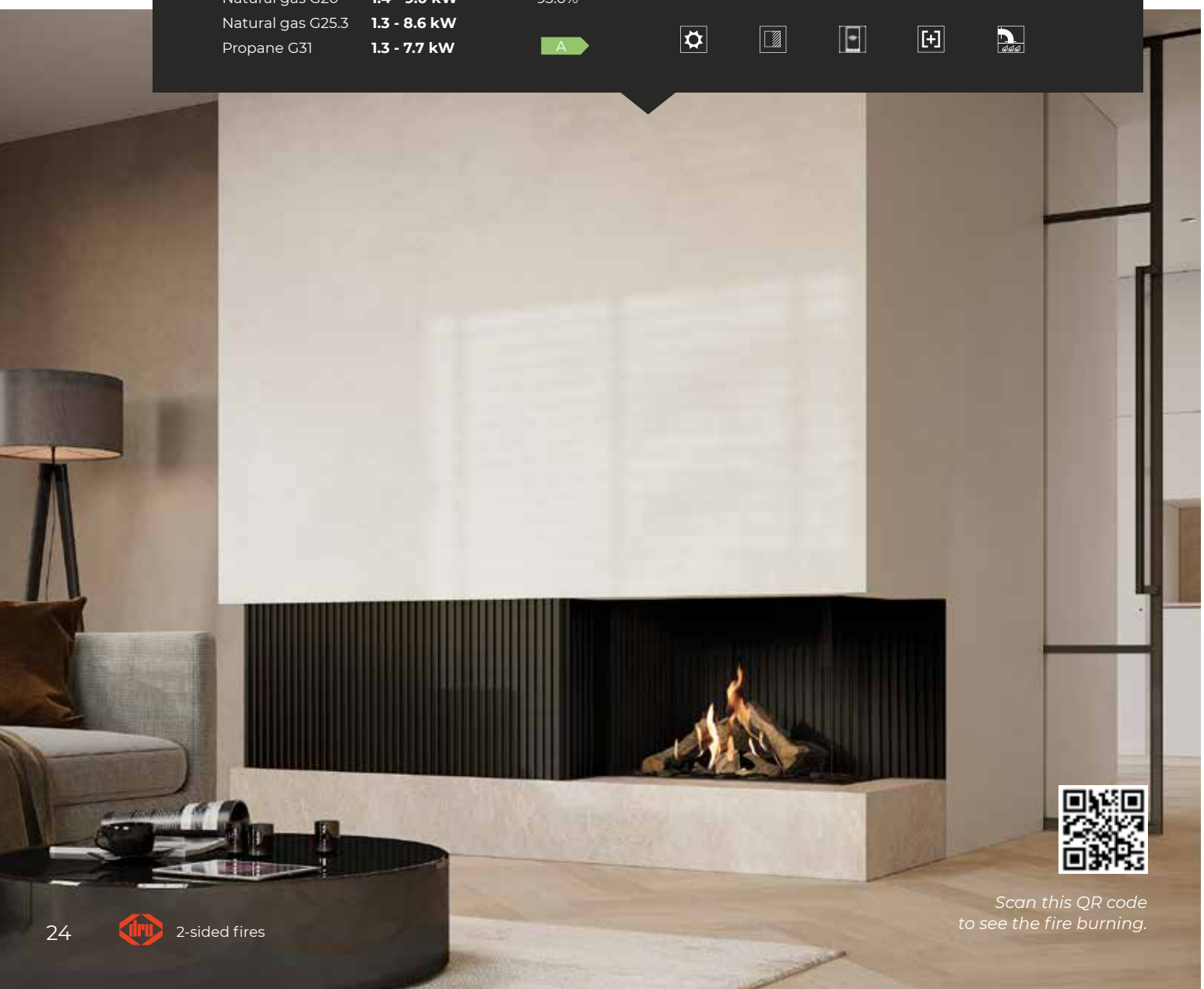

Scan this QR code
to see the fire burning.

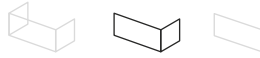

Maestro 105/2 Eco Wave

Characteristics:

- Perfect as part of TV furniture
- Can be suspended

Choose your own size:

(see p. 91 for precise dimensions)

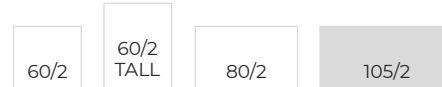

Output range

Natural gas G20	2.5 - 10.3 kW
Natural gas G25.3	2.1 - 9.8 kW
Propane G31	2.6 - 10.5 kW

Efficiency

91.2%

A

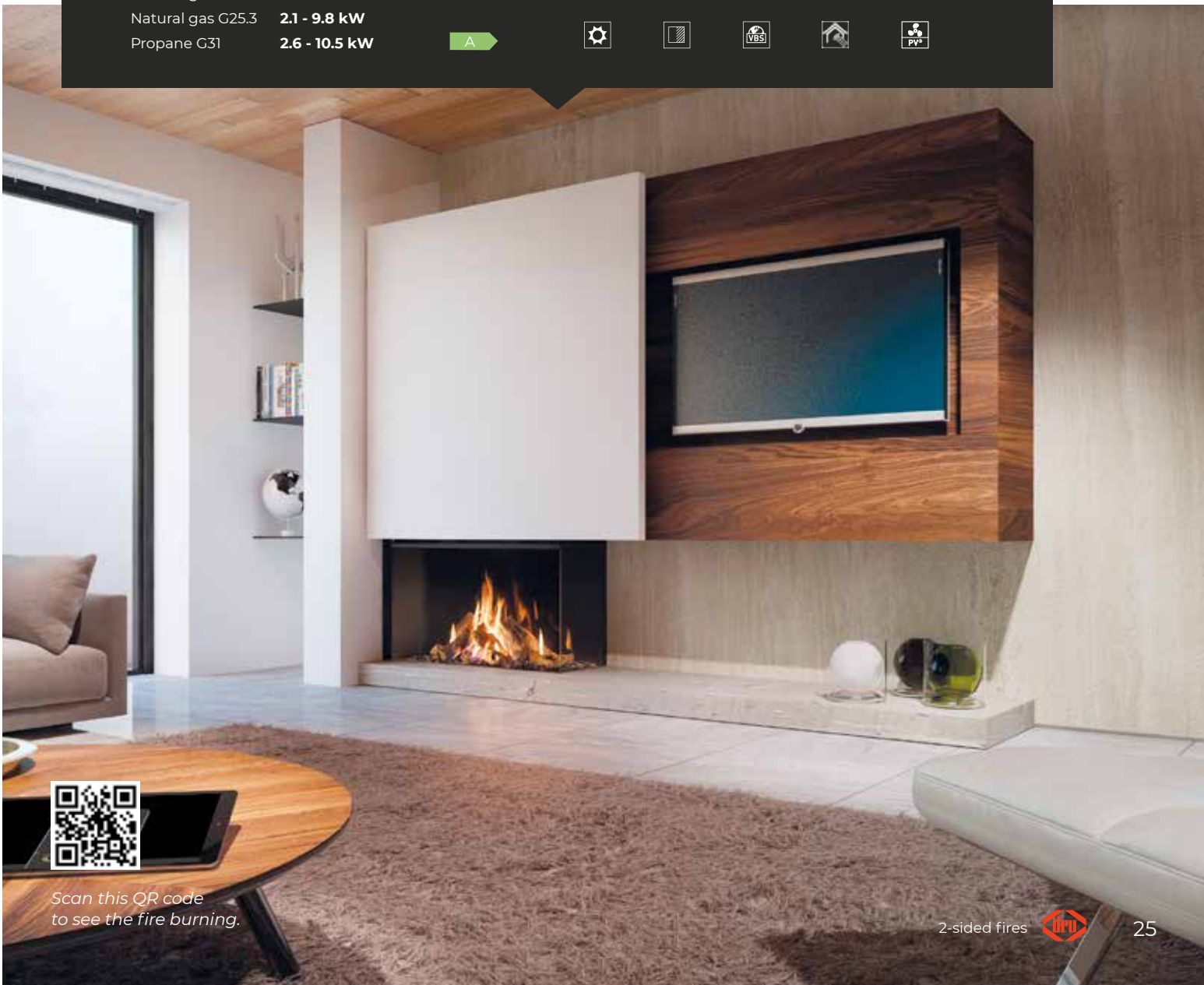

Scan this QR code
to see the fire burning.



Maestro 60 *Eco Wave*

Characteristics:

- Perfect for smaller rooms like the kitchen
- Ample view of the flames due to minimal frames

Choose your own size:

(see p. 91 for precise dimensions)

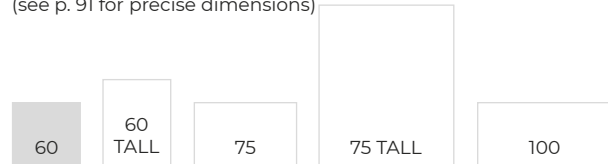

Output range

Natural gas G20	1.9 - 7.5 kW
Natural gas G25.3	1.6 - 6.8 kW
Propane G31	1.1 - 7.3 kW

Efficiency

94.3%

A



Technical specifications and icons for the fireplace, including output range, efficiency, and various features represented by icons.

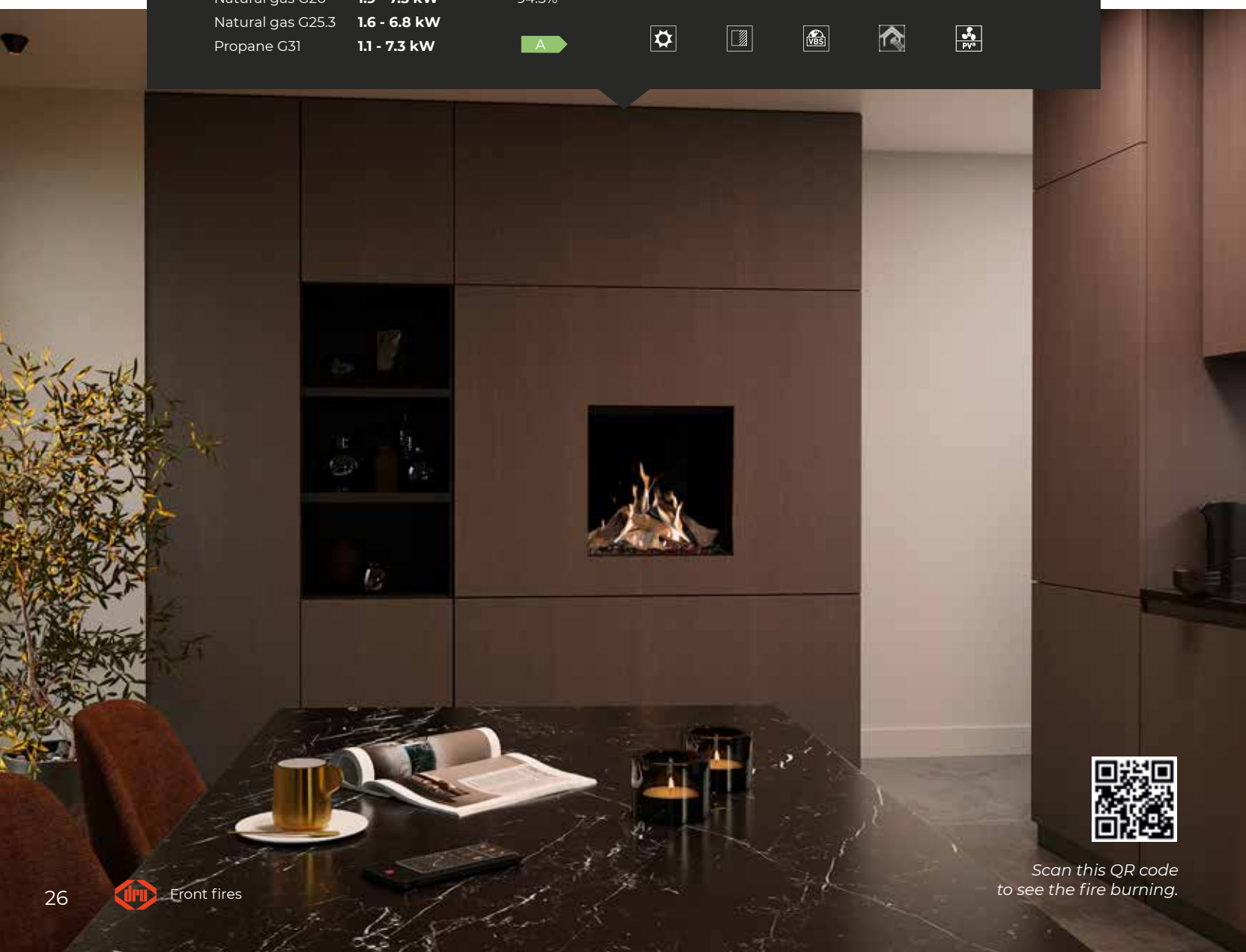

Scan this QR code to see the fire burning.



Scan this QR code to see the fire burning.



Maestro 60 Tall *Eco Wave*

Characteristics:

- Modern vertical appearance
- Also suitable for smaller rooms

Choose your own size:

(see p. 91 for precise dimensions)

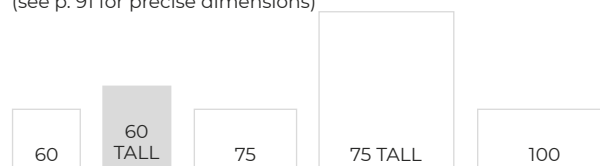

Output range		Efficiency						
Natural gas G20	1.9 - 7.2 kW	96.3%						
Natural gas G25.3	1.6 - 6.8 kW							
Propane G31	1.1 - 7.3 kW	A						



Maestro 75 Eco Wave

Characteristics:

- Energy-efficient substitute for an open fire
- Wide output range

Choose your own size:

(see p. 91 for precise dimensions)

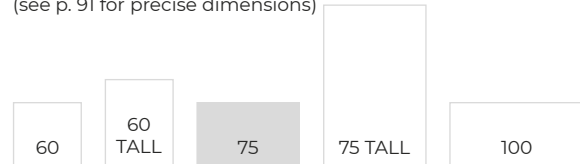

Output range	Efficiency						
Natural gas G20	89.0%						
Natural gas G25.3							
Propane G31		A					

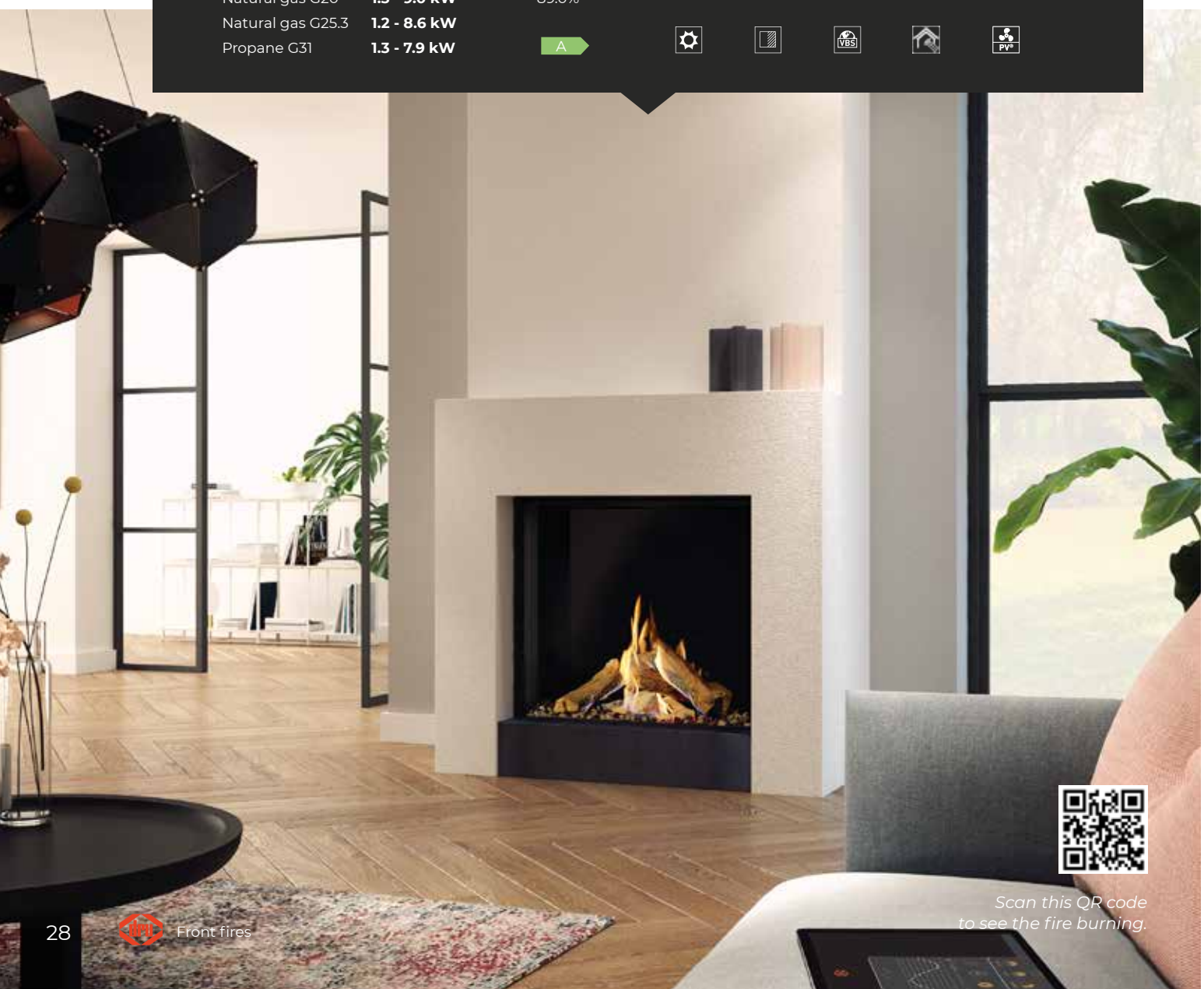

Scan this QR code to see the fire burning.



Maestro 75 Tall *Eco Wave*

Characteristics:

- Superb view of the flames
- Can also be installed free-standing

Choose your own size:

(see p. 91 for precise dimensions)

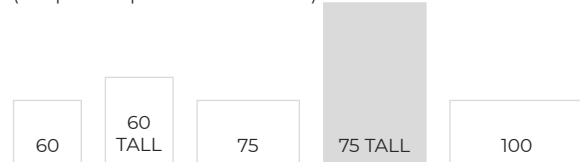

Output range

Natural gas G20	1.7 - 9.2 kW
Natural gas G25.3	1.5 - 8.7 kW
Propane G31	1.5 - 8.2 kW

Efficiency

91.0%

A



Scan this QR code
to see the fire burning.



Maestro 100 *Eco Wave*

Characteristics:

- Superb fire experience
- Ample options available for luxury finish

Choose your own size:

(see p. 91 for precise dimensions)

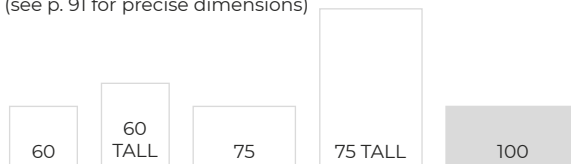

Output range

Natural gas G20	2.3 - 10.0 kW
Natural gas G25.3	1.9 - 9.3 kW
Propane G31	2.3 - 10.2 kW

Efficiency

92.1%

A





Scan this QR code
to see the fire burning.



Maestro 75 Tunnel *Eco Wave*

Characteristics:

- Subtle, elegant tunnel fire
- Enjoy a beautiful fire from 2 rooms

Choose your own size:

(see p. 91 for precise dimensions)

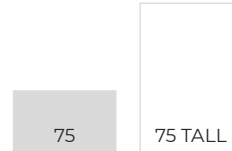

Output range		Efficiency						
Natural gas G20	1.7 - 9.1 kW	93.0%						
Natural gas G25.3	1.5 - 8.5 kW							
Propane G31	1.9 - 9.5 kW							



Scan this QR code to see the fire burning.



Scan this QR code to see the fire burning.



Maestro 75 Tunnel Tall *Eco Wave*

Characteristics:

- Room divider with high glass window
- Optimum fire experience in 2 rooms

Choose your own size:

(see p. 91 for precise dimensions)

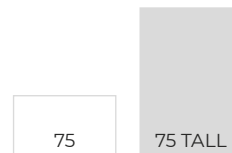

Output range		Efficiency						
Natural gas G20	2.0 - 10.2 kW	92.0%						
Natural gas G25.3	1.7 - 9.5 kW							
Propane G31	2.0 - 10.0 kW	A						

i am metro

Keen to have even more atmosphere in your living room? Then pick me!
I'm a little wider than the other members of my family and will make your home
extra cosy as a result. And did you know that my zigzag burners can create even
wider, deeper flames? For maximum enjoyment!



3-sided XTU

100XTU *Eco Wave*



3-sided XTL

100XTL *Eco Wave*
130XTL *Eco Wave*



3-sided

100XT/3 *Eco Wave*
130XT/3 *Eco Wave*



2-sided

100XT/2 *Eco Wave*
130XT/2 *Eco Wave*



Front

80XT *Eco Wave*
100XT *Eco Wave*
130XT *Eco Wave*
150XT *Eco Wave*
200XT *Eco Wave*



Tunnel

80XT Tunnel *Eco Wave*
100XT Tunnel *Eco Wave*
130XT Tunnel *Eco Wave*
150XT Tunnel *Eco Wave*
200XT Tunnel *Eco Wave*

flame



Vario Burner

The wide, high, playfully zigzagging flames fill the whole fireplace.

control

Controlling your fire is really straightforward with the **remote control** that comes with me as standard



Also use our handy **free DRU Fire app** for full control over your fire.



Easy connection for control via your Home Domotica System



Black

Ceraglass

useful to know



Easy release door system

Easy release door system means you do not have to use any force when opening your fire. What's more, this handy drop-down door is ideal for cleaning your fire.



PowerVent®

PowerVent® is a plug & play concentric extraction system with fan. The flexibility of this extraction system makes it possible to install a gas fire in practically any situation.



Direct flue

We will happily give you full freedom to install your fire wherever you want. You could (for example) have the extraction for your fire run through the façade. The extractor will connect straight up to the fire and run with a 90° bend

choose your look

Interior

Black or ceraglass - which would suit your interior best?



Glass window

Choose our unique Clear View glass: anti-reflective glass providing an optimum view of the flames.

Burner bed

Last but not least, choose a suitable burner bed. The Metro collection comes in the following colours: log set brown, log set white, stone white, stone grey or glass anthracite.



Log set brown



Log set white



Stone grey



Stone white



Glass anthracite



Frames

Our fires come with a frame as standard, but are also available with customised frames or frameless.



VBS

All DRU gas fires come with the VBS system. This system ensures that, irrespective of the composition of various types of gas, your fire will always keep burning. Not got a permanent natural gas connection? No problem. Our fires also work on butane, biogas or biopropane.

sustainability



Eco Wave

Reduce your gas consumption by up to 50%, without affecting the atmosphere in your home.

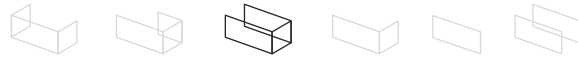

Metro 100XTU *Eco Wave*

Characteristics:

- Interior fully in line with your wishes
- Can also be suspended or built in semi-high

Output range

Natural gas G20	4.3 - 9.6 kW
Natural gas G25.3	3.3 - 9.0 kW
Propane G31	4.1 - 9.1 kW

Efficiency

83.3%

B

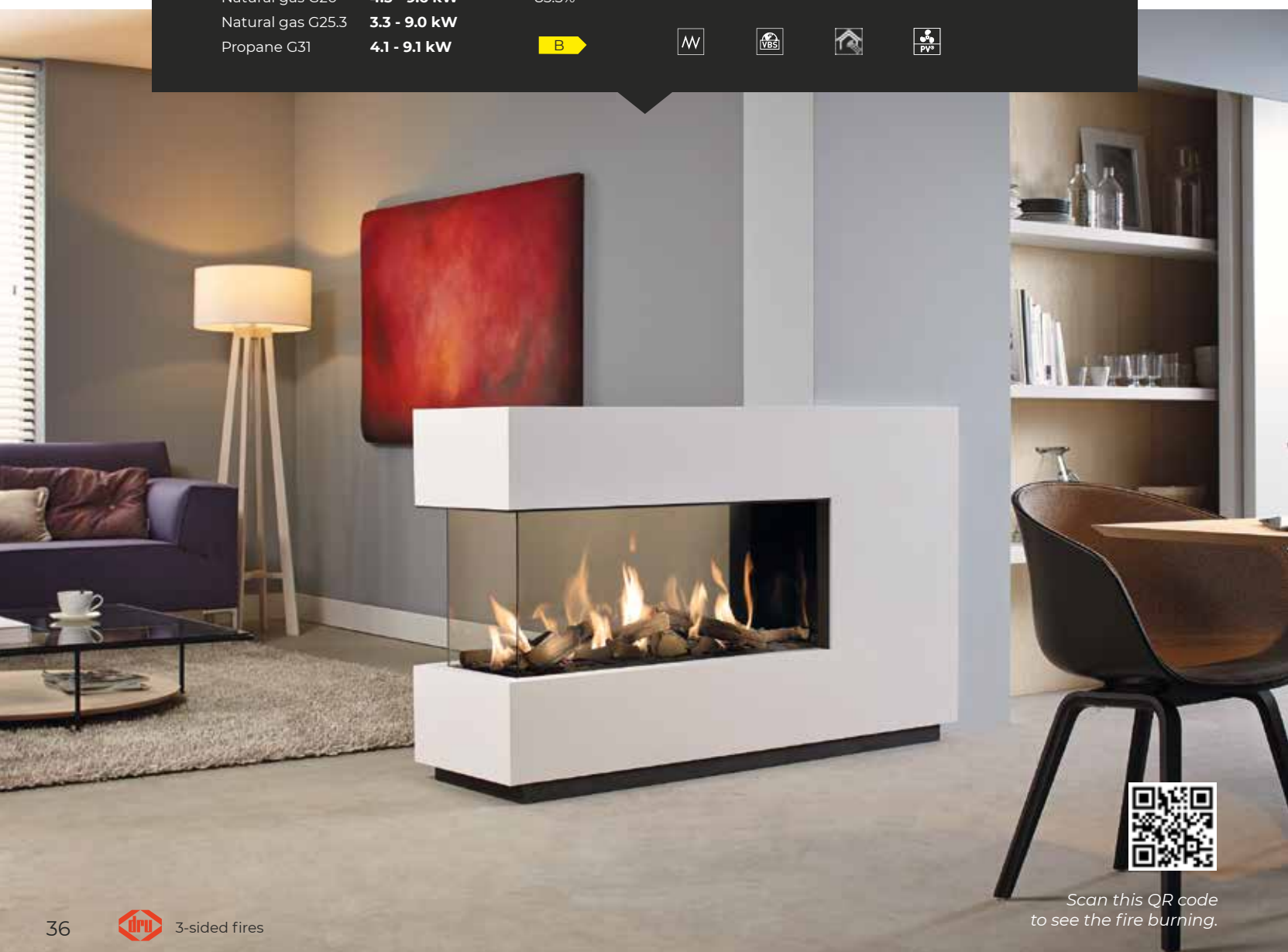

Scan this QR code
to see the fire burning.



Metro 130XTL Eco Wave



Metro 100XTL - 130XTL Eco Wave

Characteristics:

- Elegantly connects multiple rooms
- Extremely well suited to being used in corners

Choose your own size:

(see p. 91 for precise dimensions)

100XTL

130XTL

Output range 100XTL

Natural gas G20 4.3 - 9.6 kW
 Natural gas G25.3 3.3 - 9.0 kW
 Propane G31 4.1 - 9.1 kW

Efficiency 100XTL

83.3% **B**

Output range 130XTL

5.1 - 10.8 kW
 4.1 - 10.2 kW
 5.6 - 10.6 kW

Efficiency 130XTL

89.6% **A**





Metro 100XT/3 *Eco Wave*

Characteristics:

- Wide, elegant fire from every angle
- Extremely well suited to being installed in complete furniture

Choose your own size:

(see p. 92 for precise dimensions)

100XT/3

130XT/3

Output range

Natural gas G20 **4.3 - 9.6 kW**

Natural gas G25.3 **3.3 - 9.0 kW**

Propane G31 **4.1 - 9.1 kW**

Efficiency

83.3%

B

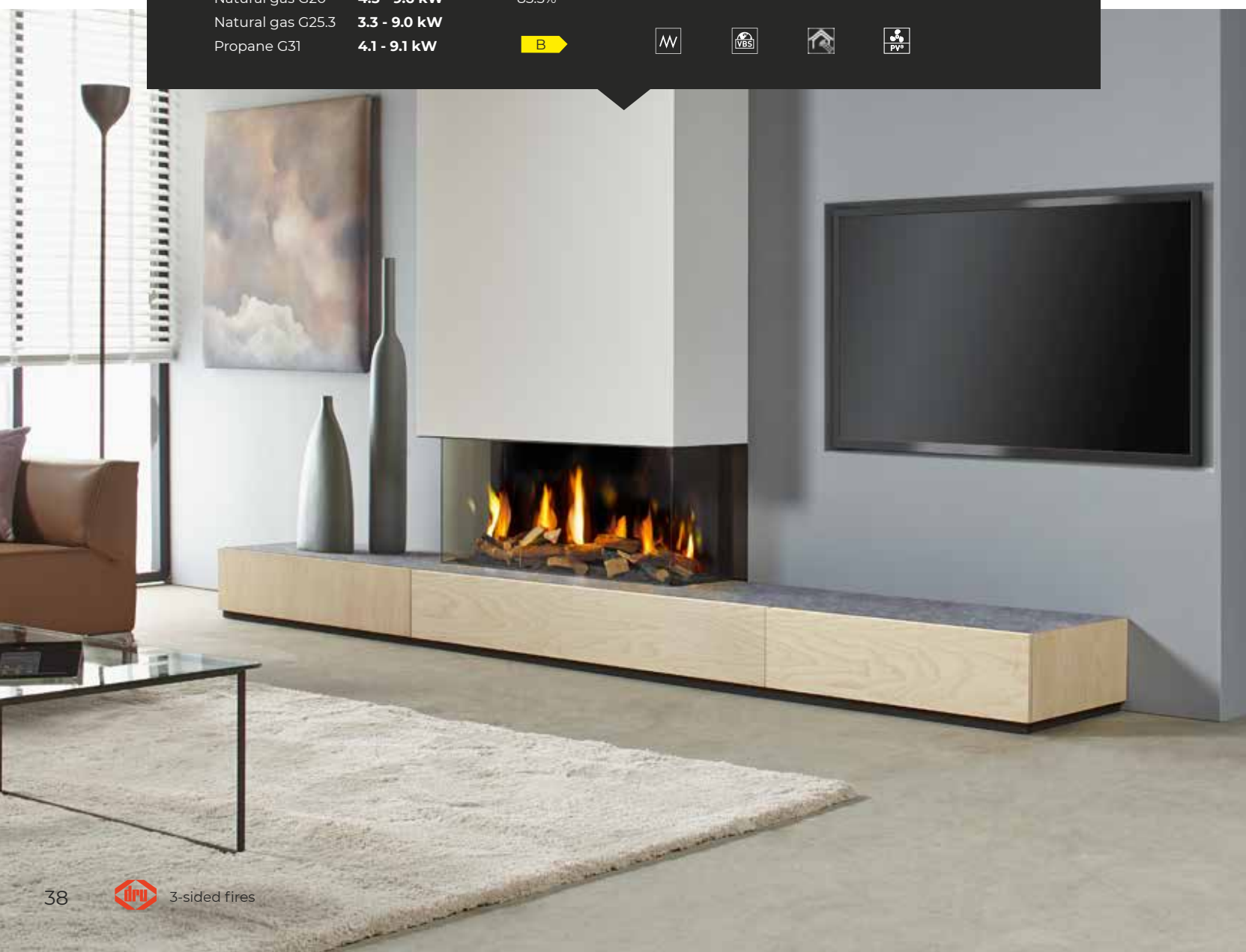



Scan this QR code to see the fire burning.



Metro 130XT/3 *Eco Wave*

Characteristics:

- Choose the most beautiful log set or stone set
- Optional anti-reflective glass

Choose your own size:

(see p. 92 for precise dimensions)

100XT/3

130XT/3

Output range

Natural gas G20 **5.1 - 10.8 kW**
 Natural gas G25,3 **4.1 - 10.2 kW**
 Propane G31 **5.6 - 10.6 kW**

Efficiency

89.6%





Metro 100XT/2 *Eco Wave*

Characteristics:

- Elegant corner fire
- Variety of burner beds available

Choose your own size:

(see p. 92 for precise dimensions)

100XT/2

130XT/2

Output range

Natural gas G20 4.3 - 9.6 kW

Natural gas G25.3 3.3 - 9.0 kW

Propane G31 4.1 - 9.1 kW

Efficiency

83.3%

B





Metro 130XT/2 Eco Wave

Characteristics:

- Perfect for integrating into media wall
- Can be built in frameless

Choose your own size:

(see p. 92 for precise dimensions)

100XT/2

130XT/2

Output range

Natural gas G20	5.1 - 10.8 kW
Natural gas G25.3	4.1 - 10.2 kW
Propane G31	5.6 - 10.6 kW

Efficiency

89.6%

A



Scan this QR code
to see the fire burning.



Metro 80XT *Eco Wave*

Characteristics:

- Ample, playful view of the flames
- Perfect for smaller rooms

Choose your own size:

(see p. 92 for precise dimensions)

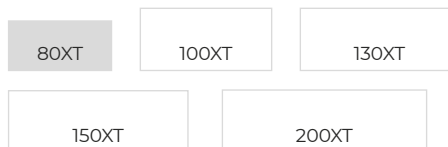

Output range

Natural gas G20	3.0 - 5.4 kW
Natural gas G25.3	2.3 - 5.1 kW
Propane G31	2.8 - 5.7 kW

Efficiency

88.9%

A





DESIGN



Metro 100XT *Eco Wave*

Characteristics:

- Choose modern: glass anthracite burner bed
- Zigzagging fire over the full width and depth

Choose your own size:

(see p. 92 for precise dimensions)

80XT 100XT 130XT

150XT 200XT



Output range

Natural gas G20	4.3 - 9.6 kW
Natural gas G25.3	3.3 - 9.0 kW
Propane G31	4.1 - 9.1 kW

Efficiency

83.3%

B





Metro 130XT - 150XT *Eco Wave*

Characteristics:

- Fire over the full width and depth
- Interior fully in line with your wishes

Choose your own size:

(see pp. 92 + 93 for precise dimensions)

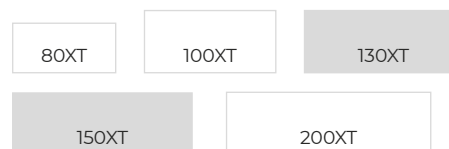

Output range 130XT

Natural gas G20 5.1 - 10.8 kW

Natural gas G25.3 4.1 - 10.2 kW

Propane G31 5.6 - 10.6 kW

Efficiency 130XT

89.6% A

Output range 150XT

5.9 - 10.8 kW

4.9 - 10.3 kW

5.3 - 11.1 kW

Efficiency 150XT

87.9% A



Scan this QR code
to see the fire burning.



Scan this QR code to see the fire burning.



Metro 200XT *Eco Wave*

Characteristics:

- The largest of its type
- Log set indistinguishable from real wood

Choose your own size:

(see p. 93 for precise dimensions)

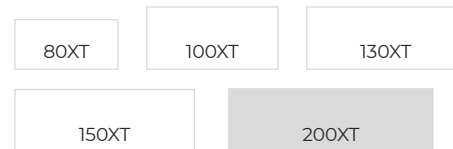

Output range		Efficiency				
Natural gas G20	8.9 - 16.7 kW	90.3%				
Natural gas G25.3	7.2 - 15.8 kW					
Propane G31	7.3 - 15.4 kW					



Metro 80XT Tunnel *Eco Wave*







Characteristics:

- Room divider widthways
- Stunning flames at viewing height

Choose your own size:

(see p. 93 for precise dimensions)



Output range		Efficiency			
Natural gas G20	3.0 - 5.4 kW	88.9%			
Natural gas G25.3	2.3 - 5.1 kW				
Propane G31	2.8 - 5.7 kW				

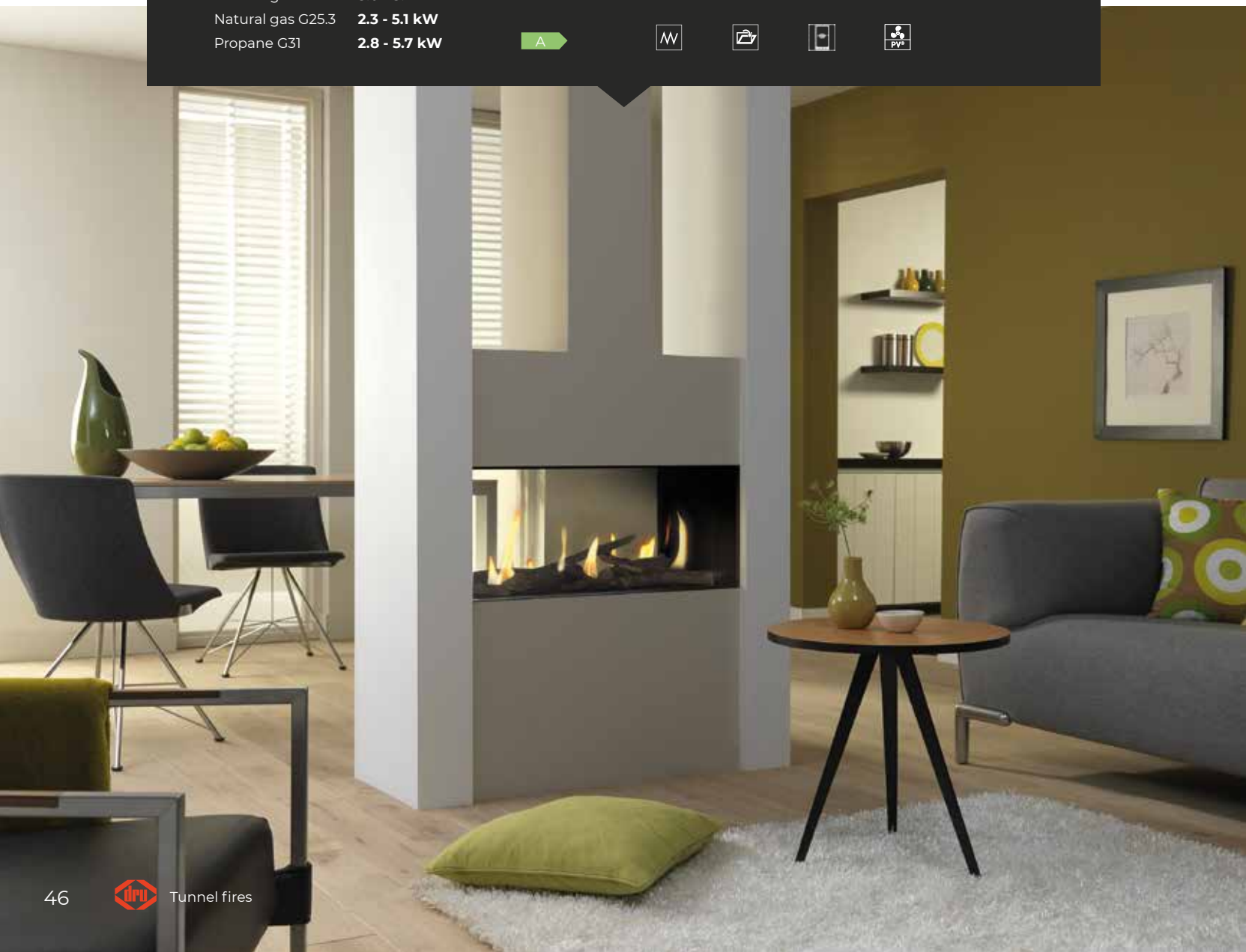



Metro 100XT Tunnel *Eco Wave*

Characteristics:

- Choose a beautiful log set or white stones
- Enjoy the fire from two sides

Choose your own size:

(see p. 93 for precise dimensions)

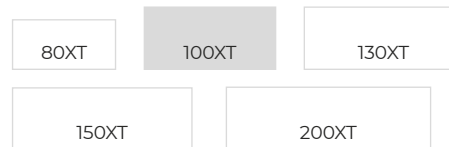

Output range		Efficiency				
Natural gas G20	4.3 - 9.6 kW	83.3%				
Natural gas G25.3	3.3 - 9.0 kW	B				
Propane G31	4.1 - 9.1 kW					



Metro 130XT Tunnel *Eco Wave*





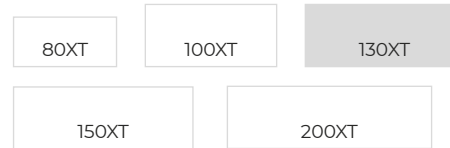

Characteristics:

- Impressive fire over the entire width
- Subtle, elegant room divider

Choose your own size:

(see p. 92 for precise dimensions)



Output range		Efficiency			
Natural gas G20	5.1 - 10.8 kW	89.6%			
Natural gas G25.3	4.1 - 10.2 kW				
Propane G31	5.6 - 10.6 kW				

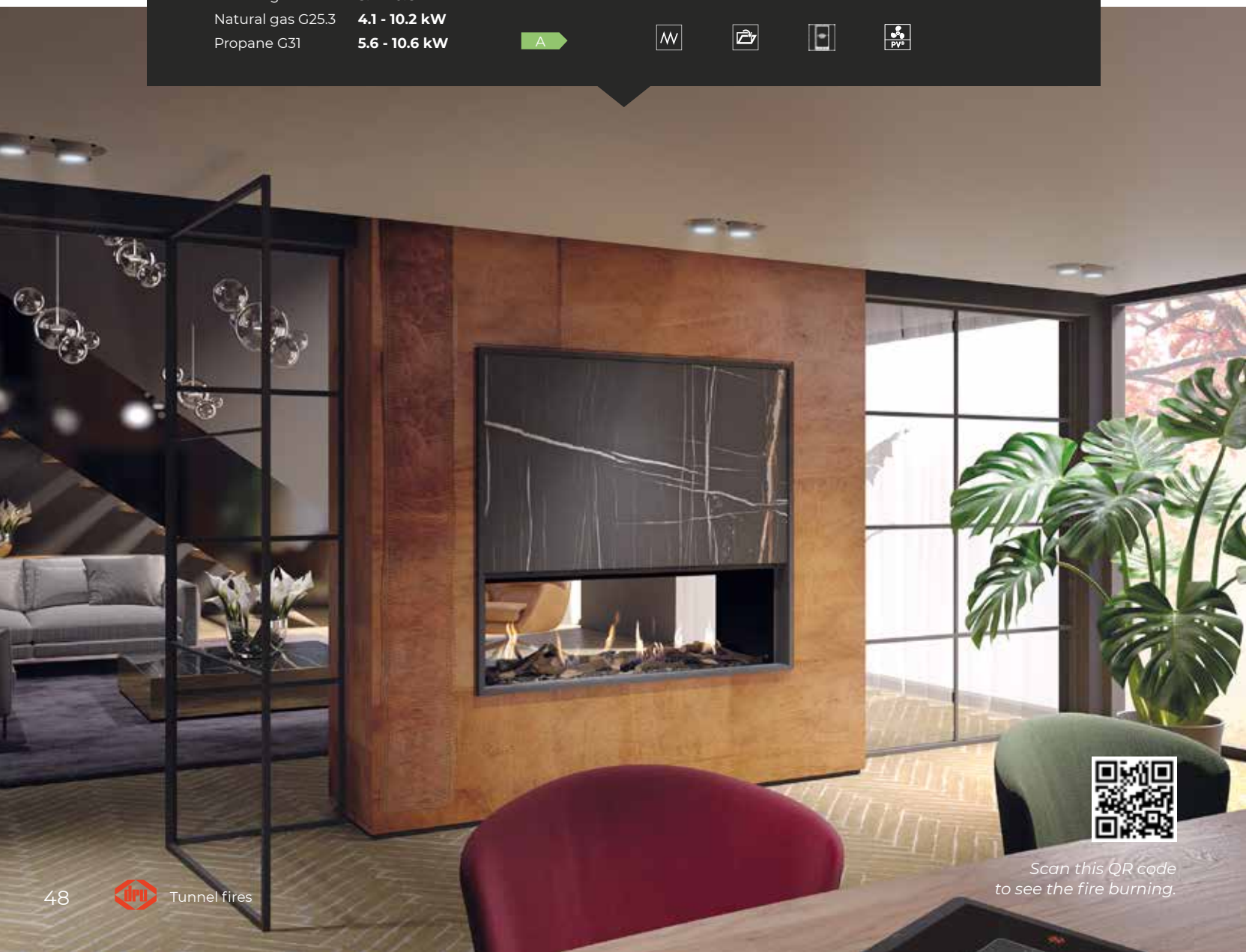

Scan this QR code to see the fire burning.



Metro 150XT Tunnel Eco Wave



Metro 150XT - 200XT Tunnel Eco Wave

Characteristics:

- Wide, generous tunnel fires
- Plenty of heat, according to your wishes

Choose your own size:

(see p. 93 for precise dimensions)

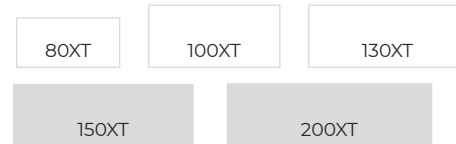

Output range 150XT Tunnel		Output range 200XT Tunnel					
Natural gas G20	5.9 - 10.8 kW	8.9 - 16.7 kW			Frames only for Metro 200XT		
Natural gas G25.3	4.9 - 10.3 kW	7.2 - 15.8 kW					
Propane G31	5.3 - 11.11 kW	7.3 - 15.4 kW					
Efficiency 150XT Tunnel		Efficiency 200XT Tunnel					
87.9%		90.3%					

i am lugo

The feel of an open log fire... who doesn't want that? My stacked logs will give you the outdoor experience while you're nice and cosy indoors. The fact that I don't feature any ventilation openings means my design is always sleek. Feel free to complete my design by going for 2-sided or 3-sided glass.



3-sided

70/3 Eco Wave

80/3 Eco Wave



2-sided

70/2 Eco Wave

80/2 Eco Wave

flame



Vario Burner

The wide, high, playfully zigzagging flames fill the whole fireplace.

control

Controlling your fire is really straightforward with the **remote control** that comes with me as standard



Also use our handy **free DRU Fire app** for full control over your fire.



Easy connection for control via your Home Domotica System

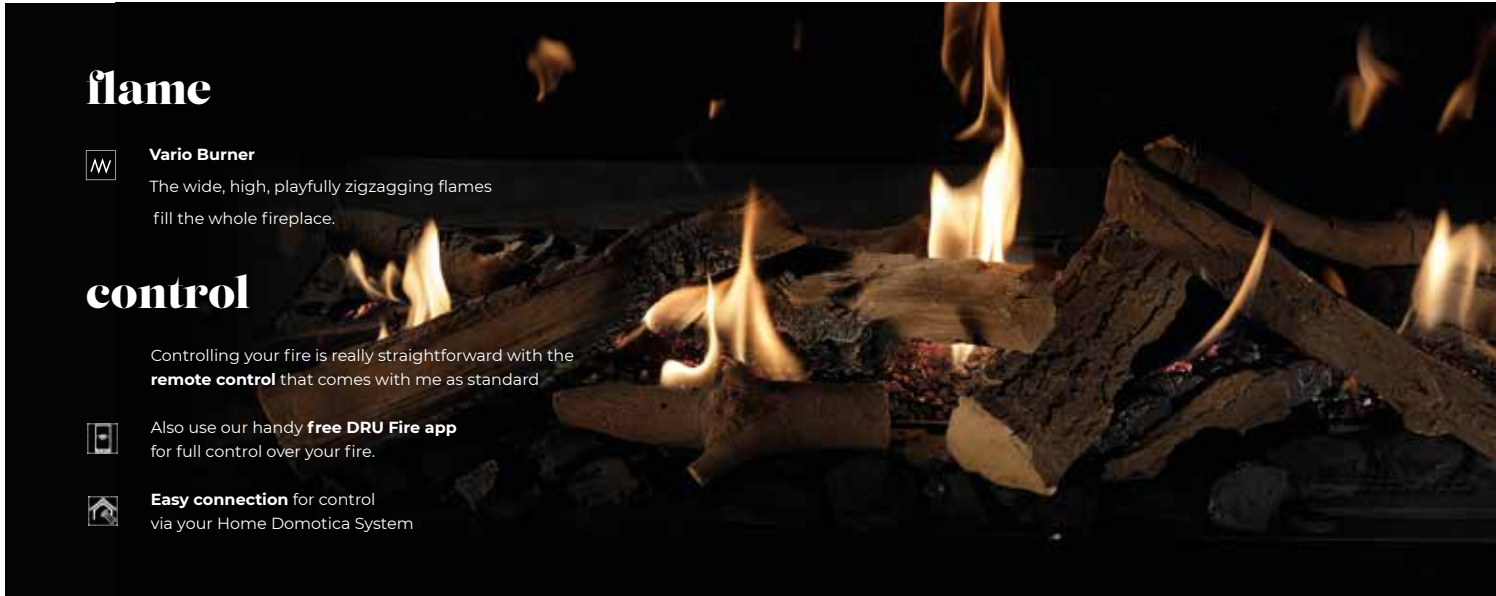

Black

Ceraglass

choose your look

Interior

Black or ceraglass - which would suit your interior best?

Burner bed

Lugo fires include a realistic log set in brown.



Log set brown

useful to know



PowerVent®

PowerVent® is a plug & play concentric extraction system with fan. The flexibility of this extraction system makes it possible to install a gas fire in practically any situation.



Frames

Our fires come with a frame as standard, but are also available with customised frames or frameless.



VBS

All DRU gas fires come with the VBS system. This system ensures that, irrespective of the composition of various types of gas, your fire will always keep burning. Not got a permanent natural gas connection? No problem. Our fires also work on butane, biogas or biopropane.

sustainability



Eco Wave

Reduce your gas consumption by up to 50%, without affecting the atmosphere in your home.



Lugo 70/3 - 80/3 *Eco Wave*

Characteristics:

- Simple, playful flames
- Perfect for smaller rooms

Choose your own size:

(see p. 93 for precise dimensions)

70/3

80/3

Output range 70/3

Natural gas G20 3.4 - 6.9 kW
Natural gas G25.3 2.8 - 6.5 kW
Propane G31 3.2 - 6.3 kW

Efficiency 70/3

91.0% ▶ A

Output range 80/3

3.4 - 6.9 kW
2.8 - 6.5 kW
3.2 - 6.3 kW

Efficiency 80/3

91.0% ▶ A

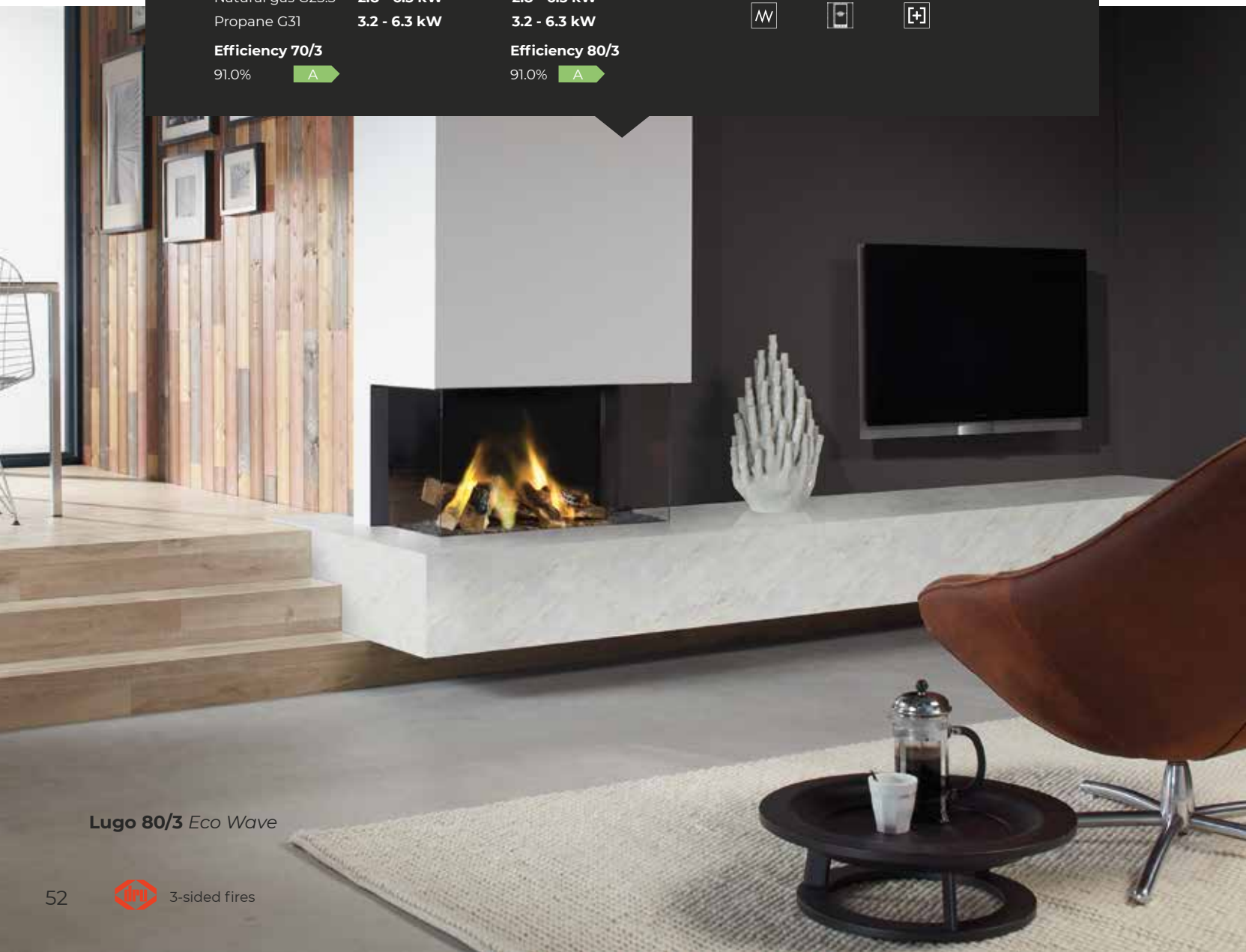

Lugo 80/3 *Eco Wave*



Lugo 70/2 Eco Wave











Lugo 70/2 - 80/2 Eco Wave

Characteristics:

- Beautiful, two-sided view of the flames and plenty of logs
- Limited installation depth

Choose your own size:

(see p. 93 for precise dimensions)

Output range 70/2		Output range 80/2		   
Natural gas G20	3.4 - 6.9 kW	Natural gas G25.3	3.4 - 6.9 kW	
Natural gas G25.3	2.8 - 6.5 kW	Propane G31	2.8 - 6.5 kW	  
Propane G31	3.2 - 6.3 kW		3.2 - 6.3 kW	
Efficiency 70/2		Efficiency 80/2		
91.0%		91.0%		

i am **COSMO**

Prefer something spectacular? Then I'm the gas fire for you!

After all, I'm the largest atmospheric fire running on gas, making me the ultimate showpiece for large rooms. Despite my size, I can be built in extremely snugly or combined with a surround.



Front

Cosmo Eco Wave



Tunnel

Cosmo Tunnel Eco Wave

flame



Vario Burner

The wide, high, playfully zigzagging flames fill the whole fireplace.

control

Controlling your fire is really straightforward with the **remote control** that comes with me as standard



Also use our handy **free DRU Fire app** for full control over your fire.



Easy connection for control via your Home Domotica System



Black

choose your look

Interior

The Cosmo fire comes with a black internal lining as standard.

Glass window



Choose our unique Clear View glass: anti-reflective glass providing an optimum view of the flames.

Surround

The Cosmo is also available with a stunning 'Murano' surround with stainless steel casing and limestone hearth.

Burner bed

Cosmo fires include a realistic log set in brown.



Log set brown

useful to know



Easy release door system

Easy release door system means you do not have to use any force when opening your fire. What's more, this handy drop-down door is ideal for cleaning your fire.



PowerVent®

PowerVent® is a plug & play concentric extraction system with fan. The flexibility of this extraction system makes it possible to install a gas fire in practically any situation.



VBS

All DRU gas fires run on various types of gas. Not got a permanent natural gas connection? No problem. Our fires also work on butane, biogas or biopropane.

sustainability



Eco Wave

Reduce your gas consumption by up to 50%, without affecting the atmosphere in your home.



Cosmo *Eco Wave*

Characteristics:

- Wide output range makes it very well suited to use in hotels, restaurants and cafés
- Optional stunning 'Murano' surround

Output range

Natural gas G20 **6.0 - 16.3 kW**

Natural gas G25.3 **4.9 - 15.7 kW**

Efficiency

89.3%

A

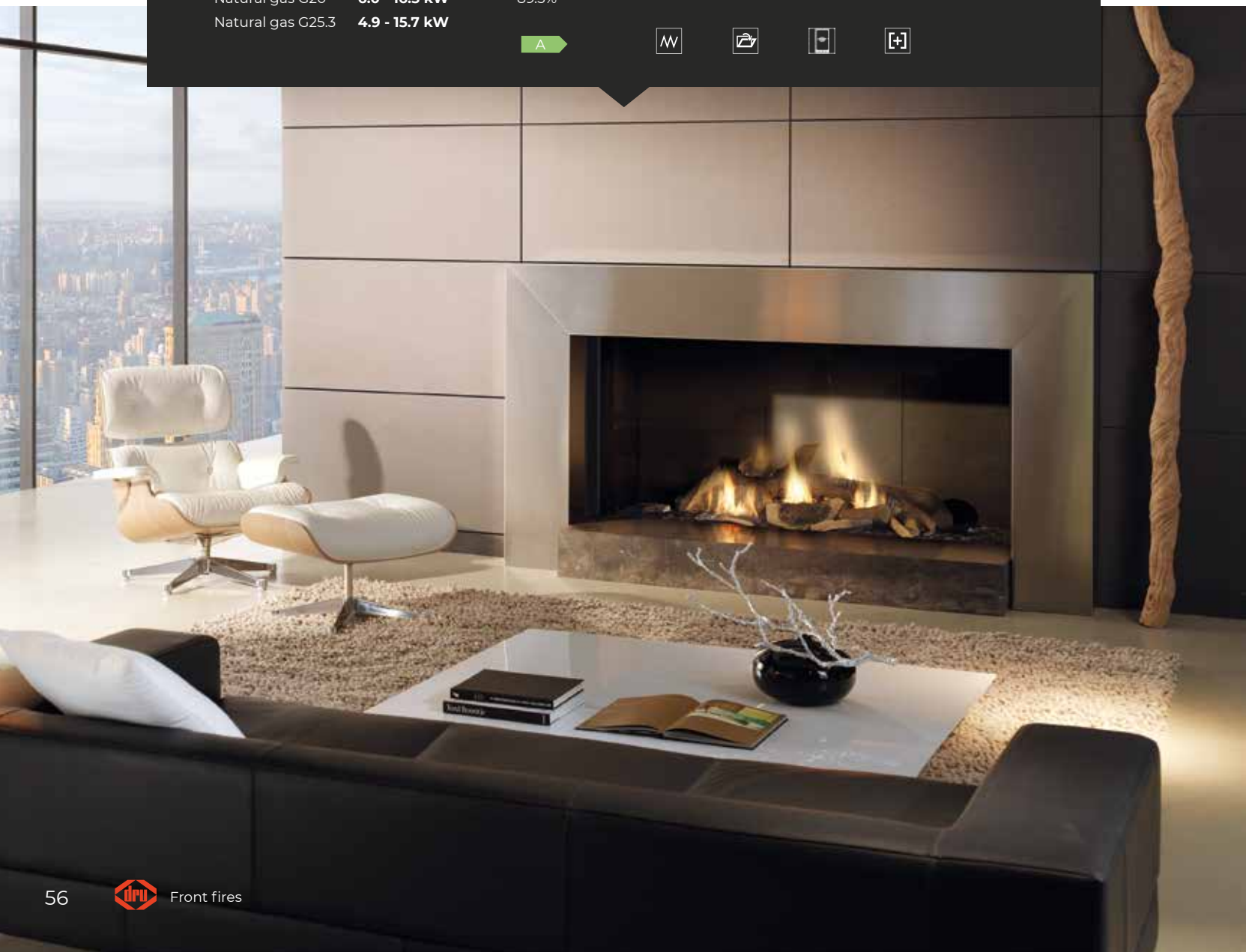













Cosmo Tunnel *Eco Wave*

Characteristics:

- Ultimate eye-catching feature in large rooms
- Extremely beautiful, robust log set

Output range		Efficiency					
Natural gas G20	6.0 - 16.3 kW	89.3%					
Natural gas G25.3	4.9 - 15.7 kW						

i am **paco**

My compact design makes me ideal for a corner.

Though you can also install me against a flat wall in your living room, of course.

Prefer to install me away from the retaining wall? No problem.

I've got a special extension set for that. Whatever position you choose,

I'll always ensure a beautiful glow effect from every angle.



2-sided

Paco Eco Wave

flame



Line Burner

Sleek flames across the entire width of the fire.

control

Controlling your fire is really straightforward with the **remote control** that comes with me as standard



Also use our handy **free DRU Fire app** for full control over your fire.



Easy connection for control via your Home Domotica System



Ceraglass

choose your look

The Paco is a great basic fire, but with one special detail: the flames are illuminated with a beautiful glow effect.

Burner bed

Paco fires all include a realistic brown log set.



Log set brown

useful to know



PowerVent®

PowerVent® is a plug & play concentric extraction system with fan. The flexibility of this extraction system makes it possible to install a gas fire in practically any situation.



VBS

All DRU gas fires come with the VBS system. This system ensures that, irrespective of the composition of various types of gas, your fire will always keep burning. Not got a permanent natural gas connection? No problem. Our fires also work on butane, biogas or biopropane.

sustainability



Eco Wave

Reduce your gas consumption by up to 50%, without affecting the atmosphere in your home.



Paco Eco Wave



Paco outset

Characteristics:

- Versatile fire for corner or flat wall
- Compact size with low output

Output range

Natural gas G20 **2.6 - 5.4 kW**

Natural gas G25.3 **2.1 - 5.0 kW**

Efficiency

84.8%

B





i am free-standing

Flexible is my middle name. For instance, you can configure my interior and exterior entirely yourself. Whether you want to hang me up or install me in the middle of your living room... I go well in any room. Even if that's exactly what you want to save money on.



3-sided

Diablo Next

Circo

Convexo *Eco Wave*

Maestro 60/3 Module *Eco Wave*

Passo *Eco Wave*

Polo

Trio

flame



Line Burner

Sleek flames across the entire width of the fire.

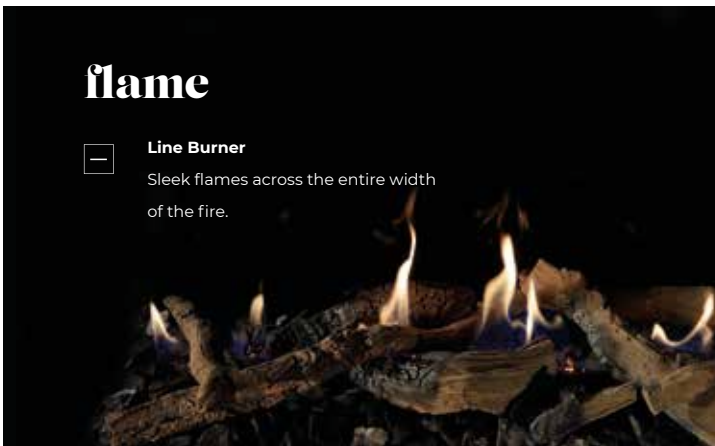

Dynamic Flame Burner®

Lively, natural flames built like a real log fire. The double burners ensure extra height and depth in the fire.



control

Controlling your fire is really straightforward with the **remote control** that comes with me as standard



Also use our handy **free DRU Fire app** for full control over your fire.



Easy connection for control via your Home Domotica System



Black

Ceraglass

choose your look

Interior

Black or ceraglass - which would suit your interior best?



Glass window

Choose our unique Clear View glass: anti-reflective glass providing an optimum view of the flames.

Burner bed

The free-standing fires include a realistic log set in brown.



Log set brown

useful to know



Easy release door system

Easy release door system means you do not have to use any force when opening your fire. What's more, this handy drop-down door is ideal for cleaning your fire.



VBS

All DRU gas fires come with the VBS system. This system ensures that, irrespective of the composition of various types of gas, your fire will always keep burning. Not got a permanent natural gas connection? No problem. Our fires also work on butane, biogas or biopropane.

sustainability



Eco Wave

Reduce your gas consumption by up to 50%, without affecting the atmosphere in your home.



Eco Glow

Prefer to drop the heat and keep the atmosphere? Then switch to the illuminated glow bed.



Maestro 60/3 Module *Eco Wave*

Characteristics:

- Luxury gas fire with the look of a log fire
- Available in white or grey aluminium casing

Aluminium cover:

- White or grey

Output range

Natural gas G20	1.9 - 7.2 kW
Natural gas G25.3	1.6 - 6.8 kW
Propane G31	1.1 - 7.3 kW

Efficiency

94.3%

A

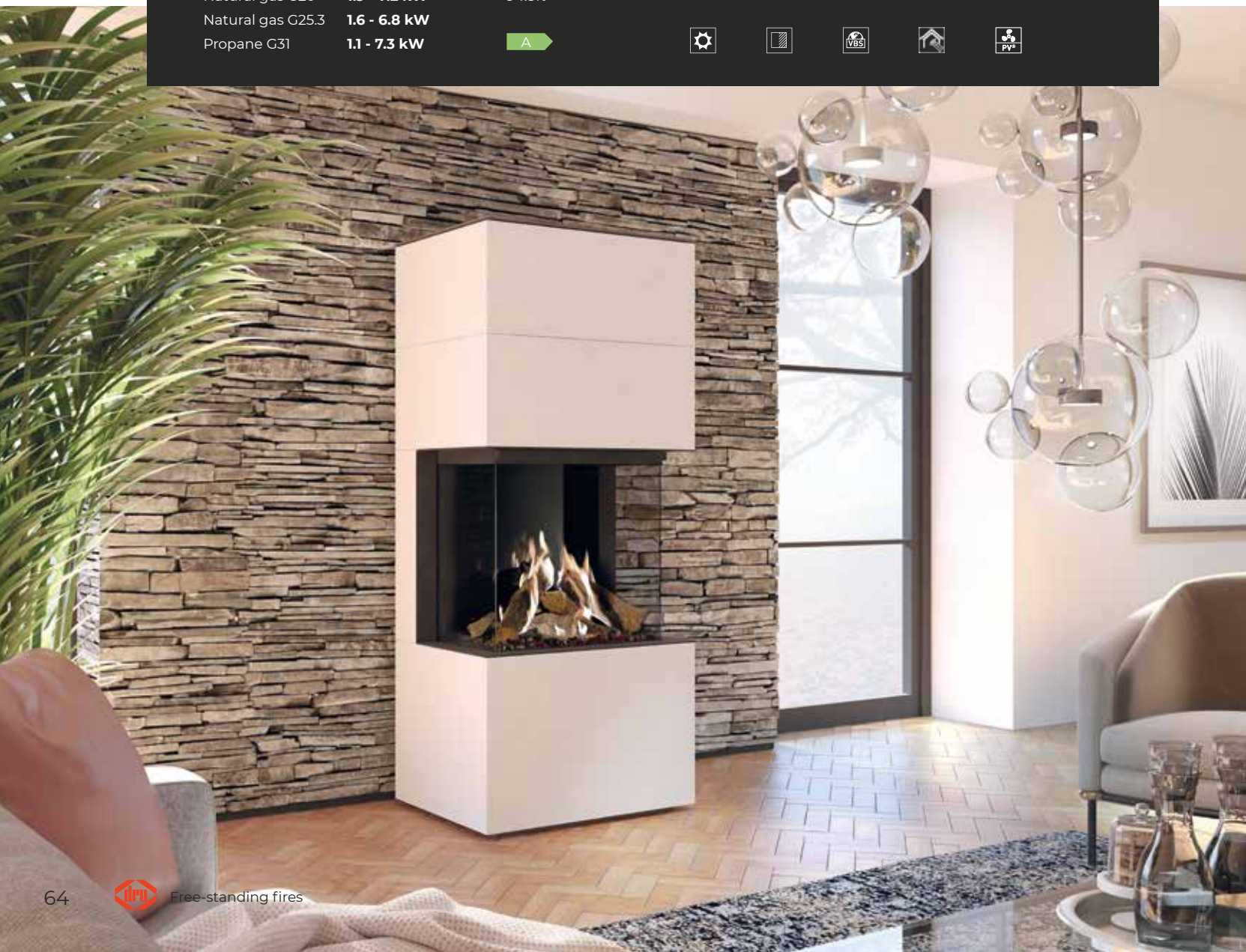











Scan this QR code to see the fire burning.



Convexo Eco Wave

Characteristics:

- Beautifully curved glass window
- Suitable for both natural gas and (bio) propane gas

Output range		Efficiency				
Natural gas G20	2,6 - 5,0 kW	92,4%				
Natural gas G25.3	2,1 - 4,7 kW					
Propane G31	2,6 - 5,0 kW					



Passo *Eco Wave*

Characteristics:

- 180° view of stunning, high flames
- Available in 6 colours



Nero



Titan



Pearl

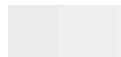

White



Light grey



Turquoise

Output range

Natural gas G20 **1.2 - 6.4 kW**

Natural gas G25.3 **0.9 - 6.1 kW**

Efficiency

93.0%

A





Scan this QR code
to see the fire burning.





Polo

Characteristics:

- Elegant in small rooms
- Very low output

Output range

Natural gas G20	1.6 - 4.1 kW
Natural gas G25.3	1.5 - 3.8 kW
Propane G31	1.6 - 3.8 kW

Efficiency

92.6%

A



Scan this QR code
to see the fire burning.









Scan this QR code to see the fire burning.



Diablo Next

Characteristics:

- Goes well anywhere, without using up any floor space
- Choose a black or alu-metallic finish

Output range		Efficiency		
Natural gas G20	1.6 - 4.1 kW	92.6%		
Natural gas G25.3	1.5 - 3.8 kW			
Propane G31	1.6 - 3.8 kW			



Circo

Characteristics:

- Robust atmospheric fire for any room
- Round glass pane providing ample view of the flames

Output range

Natural gas G20 2.9 - 7.0 kW

Natural gas G25.3 2.7 - 6.0 kW

Propane G31 2.8 - 6.2 kW

Efficiency

92.5%

A



Informational overlay box containing technical specifications and icons.



Scan this QR code
to see the fire burning.





Scan this QR code
to see the fire burning.



Trio Black Edition

Characteristics:

- Slender forms with robust look
- High flame picture from 3 sides

Output range

Natural gas G20	2.0 - 4.5 kW
Natural gas G25.3	1.8 - 4.2 kW
Propane G31	1.5 - 4.0 kW

Efficiency

85.4%

B



i am global

Small living room? I'm perfect for that. I'm nice and compact and very competitively priced, you see. Install me wherever you want, whether that's in a well-insulated property or one with an existing chimney.

In short, if it's accessibility you want, then go for Global!



3-sided

100 Triple
120 Triple



2-sided

60 *Corner*
100 *Corner*
120 *Corner*



Front

55XT BF
55XT BF Cavity
70XT BF
100 BF
120 BF
55XT CF
70XT CF

flame



Line Burner

Sleek flames across the entire width of the fire.



TruFlame Burner®

Extra-high flames in a natural log fire set-up.

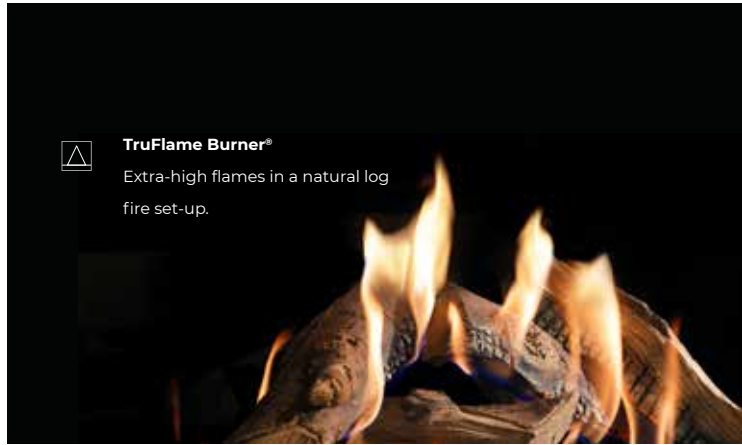

control

Controlling your fire is really straightforward with the **remote control** that comes with me as standard



Easy connection for control via your Home Domotica System



Black

Ceraglass

Classic stone (DRU Global)

useful to know



Direct flue

We will happily give you full freedom to install your fire wherever you want. You could (for example) have the extraction for your fire run through the façade. The extractor will connect straight up to the fire and run with a 90° bend



VBS

All DRU gas fires come with the VBS system. This system ensures that, irrespective of the composition of various types of gas, your fire will always keep burning. Not got a permanent natural gas connection? No problem. Our fires also work on butane, biogas or biopropane.

choose your look

Interior

With our DRU Global fires, you have a choice of 3 types of internal lining.



Glass window

Choose our unique Clear View glass: anti-reflective glass providing an optimum view of the flames.

Burner bed

Last but not least, choose a suitable burner bed. The DRU Global collection comes in the following colours: log set brown, stone white or glass anthracite



Log set brown



Stone white



Glass anthracite



Global 100 Triple BF - 120 Triple BF

Characteristics:

- Panoramic view of the flames
- Choose your own burner bed
(wood/stone/glass)

Choose your own size:

(see p. 94 for precise dimensions)

100 Triple BF

120 Triple BF



Output range 100 Triple BF

Natural gas G20 **2.8 - 7.5 kW**
 Natural gas G25.3 **2.6 - 7.1 kW**
 Propane G31 **3.5 - 7.0 kW**

Efficiency 100 Triple BF

94,0% **A**

Output range 120 Triple BF

2.8 - 7.5 kW
2.6 - 7.1 kW
3.5 - 7.0 kW

Efficiency 120 Triple BF

94,0% **A**





Scan this QR code
to see the fire burning.



Global 100 Triple BF

3-sided fires



75



Global 60 Corner BF

Characteristics:

- Perfect for smaller rooms
- Stunning 2-sided gas fire

Choose your own size:

(see p. 94 for precise dimensions)

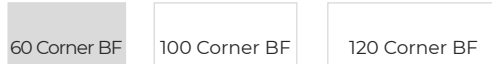

Output range

Natural gas G20	2.3 - 6.0 kW
Natural gas G25.3	2.1 - 5.4 kW
Propane G31	3.0 - 6.2 kW

Efficiency

91.5%

A



Global 120 Corner BF





Scan this QR code
to see the fire burning.



Global 100 Corner BF - 120 Corner BF

Characteristics:

- Ample view of the flames due to minimal frames
- Extremely efficient

Choose your own size:

(see p. 95 for precise dimensions)

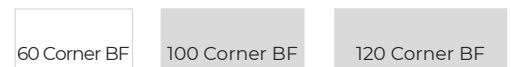

Output range 100 Corner BF

Natural gas G20 **2.8 - 7.5 kW**
 Natural gas G25.3 **2.6 - 7.1 kW**
 Propane G31 **3.5 - 7.0 kW**

Efficiency 100 Corner BF

94.0% **A**

Output range 120 Corner BF

2.8 - 7.5 kW
2.6 - 7.1 kW
3.5 - 7.0 kW

Efficiency 120 Corner BF

94.0% **A**





Global 55XT Cavity BF

Characteristics:

- Suitable for installation in a cavity wall
- Snorkel flue and convection box included



Cavity System

Output range Natural gas G20	1.8 - 3.2 kW	Efficiency 77.4%		

Only available in United Kingdom

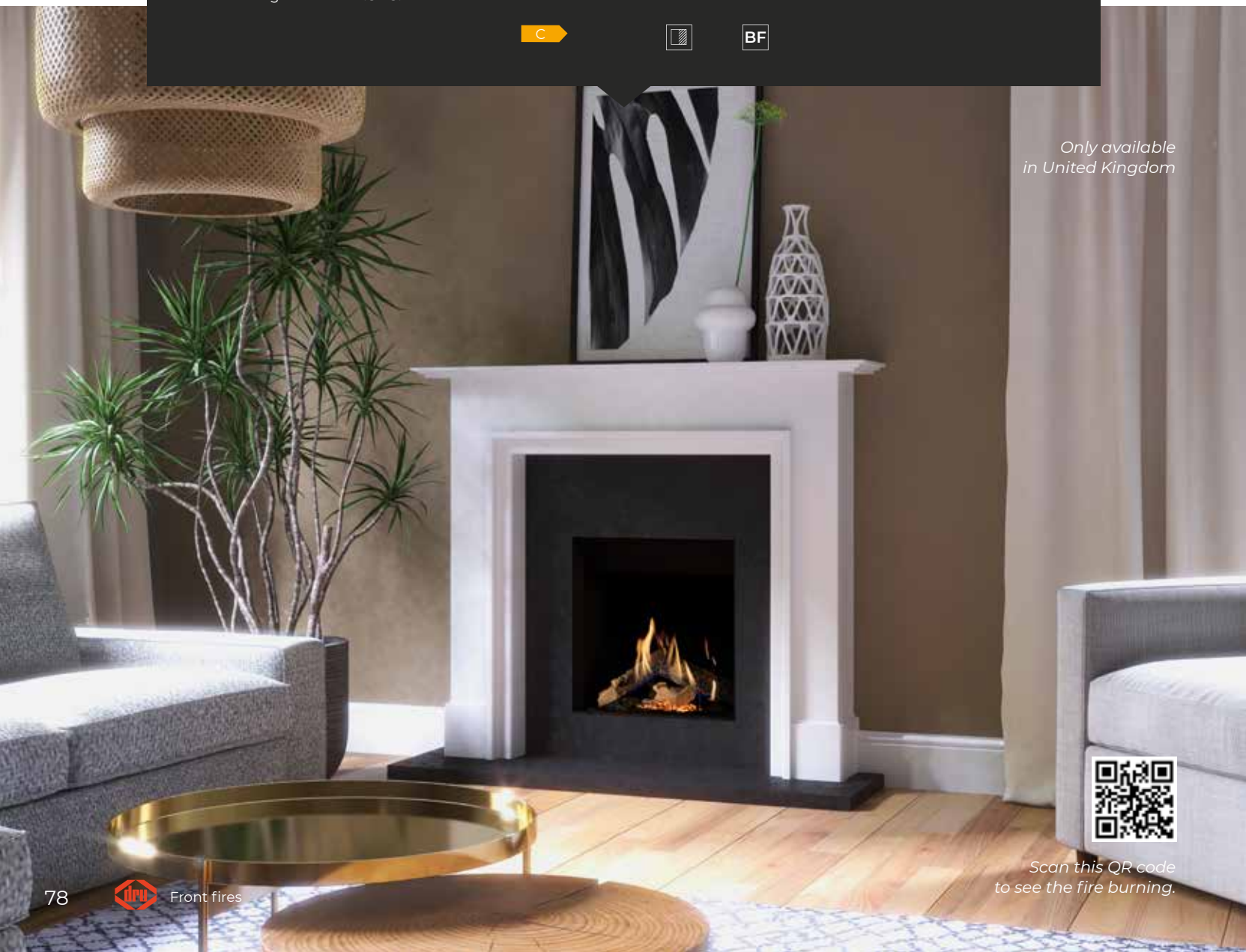

Scan this QR code to see the fire burning.



Scan this QR code to see the fire burning.



Global 55XT BF - 70XT BF





Characteristics:

- Extremely realistic high, dense flames
- Limited installation depth

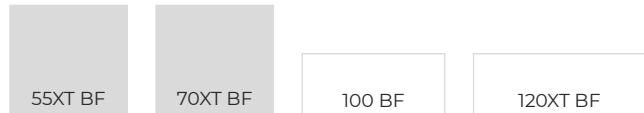
Choose your own size:

(see p. 95 for precise dimensions)



Output range 55XT BF		Output range 70XT BF		  
Natural gas G20	2.6 - 4.6 kW	3.4 - 5.7 kW		
Natural gas G25.3	2.4 - 4.3 kW	3.1 - 5.3 kW		
Propane G31	3.1 - 4.4 kW	3.2 - 5.5 kW		
Efficiency 55XT BF		Efficiency 70XT BF		
92.6%		92.7%		



Global 100 BF - 120 BF

Characteristics:

- Ample view of the beautiful flames
- Extremely efficiency and environmentally friendly

Choose your own size:

(see p. 95 for precise dimensions)



Output range 100 BF

Natural gas G20 **2.8 - 7.5 kW**
 Natural gas G25.3 **2.6 - 7.1 kW**
 Propane G31 **3.5 - 7.0 kW**

Efficiency 100 BF

94.0% **A**

Output range 120 BF

Natural gas G20 **2.8 - 7.5 kW**
 Natural gas G25.3 **2.6 - 7.1 kW**
 Propane G31 **3.5 - 7.0 kW**

Efficiency 120 BF

94.0% **A**



Global 120 BF





Global 55XT CF

Characteristics:

- Extensive choice of interiors
- Is perfect to connect up to existing chimney

Choose your own size:

(see p. 95 for precise dimensions)



Output range	Efficiency			
Natural gas G20 2.8 - 3.7 kW	74.4%			
Natural gas G25.3 2.6 - 3.5 kW				

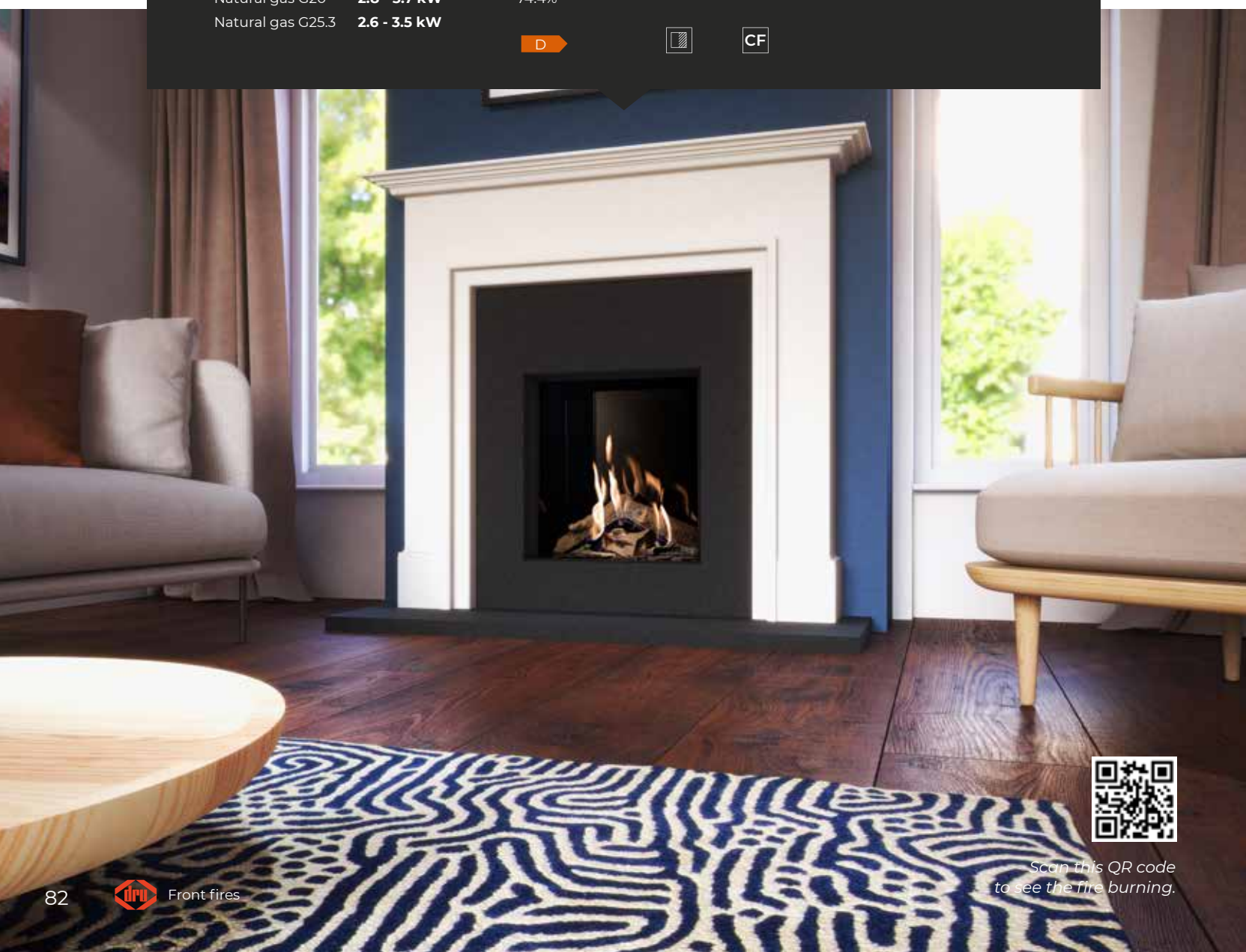

Scan this QR code to see the fire burning.



Scan this QR code to see the fire burning.



Global 70XT CF

Characteristics:

- Shallow fire that does not take up much space
- Perfect for snug fit in an existing chimney

Choose your own size:

(see p. 95 for precise dimensions)



Output range		Efficiency			
Natural gas G20	3.1 - 4.5 kW	77.1%			
Natural gas G25.3	2.7 - 4.4 kW				
Propane G31	4.0 - 4.6 kW				

a gas fire anywhere you like



PowerVent®

What is PowerVent®?

Gas fires obviously need extraction.

An existing chimney, an extractor leading out through the roof or the façade, or... our PowerVent®. PowerVent® is a plug & play concentric extraction system with fan. The flexibility of this extraction system makes it possible to install a gas fire in practically any situation. Living in an apartment, a terraced house or a property without a flue pipe?

No problem! PowerVent® gives you full freedom to install your fire wherever you want.

Benefits of DRU PowerVent®

- Extraction of up to 100 metres with a variety of bends
- Flue pipe diameter of Ø 10 cm
- Control unit in control hatch, with built-in pressure gauge
- Compact power box, which can be installed outdoors and indoors
- The perfect solution for terraced houses, apartments, restaurants, hotels, shops and farms

no chimney but still want to install a gas fire?



Existing chimney

- Via roof
- flexible pipe in chimney

No chimney



- Via roof (flat)
- straight or with bends



- Via roof (sloping)
- straight or with bends



- Via wall / Direct flue
- direct to the fire with a 90° bend to the exterior
- possible on many of the models



- Via wall
- first 1 metre vertical, then a 90° bend

PowerVent®

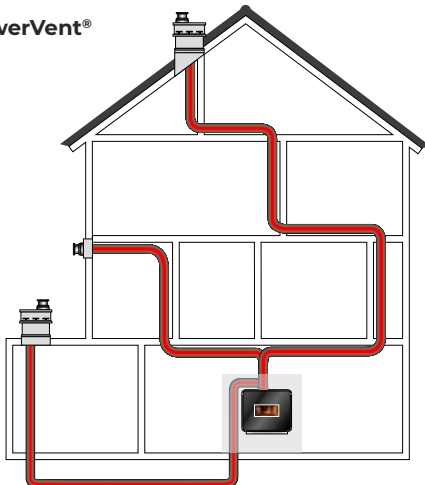

- Up to 100 metres horizontal
- Many bends possible
- Through crawl space



Scan this QR code.

**frameless
and sleek
finish**

[+] frames



Frameless, bottom of frame removed



Standard frame



Optional frame (customisation possible)

With or without frames

All our gas fires come with a frame as standard.

Prefer to integrate your gas fire seamlessly into the rest of your interior? You can!

After all, for several of our fires it is possible to remove the bottom of the frame. Thus enabling the fire to be built snugly into a natural stone plateau or (for example) recessed into the floor, directly against the glass window.

Full customisation

Want to personalise your fire a bit more?

For the built-in fires in the overview below, you choose the width of the frame yourself.

Thus ensuring that the fire is the perfect fit in your interior.

Fires that can be built in frameless			
3-sided fires	2-sided fires	Front fires	Tunnel fires
Lugo 70/3	Lugo 70/2	Cosmo	Cosmo Tunnel
Lugo 80/3	Lugo 80/2	Maestro 60	Maestro 75 Tunnel
Maestro 60/3	Maestro 60/2	Maestro 60 Tall	Maestro 75 Tunnel Tall
Maestro 60/3 Tall	Maestro 60/2 Tall	Maestro 75	Metro 200XT Tunnel
Maestro 75XTU	Maestro 80/2	Maestro 100	
Maestro 80/3	Maestro 105/2	Metro 200XT	
Maestro 105/3	Metro 100XT/2		
Metro 100XT/3	Metro 130XT/2		
Metro 100XTL			
Metro 100XTU			
Metro 130XT/3			

Optional frames			
3-sided fires	2-sided fires	Front fires	Tunnel fires
Lugo 70/3 ¹	Lugo 70/2 ¹	Metro 200XT ⁶	Metro 200XT Tunnel ⁶
Lugo 80/3 ¹	Lugo 80/2 ¹	Maestro 60 ⁴	Maestro 75 Tunnel ⁵
Maestro 60/3 ²	Maestro 60/2 ²	Maestro 60 Tall ⁴	Maestro 75 Tunnel Tall ⁵
Maestro 60/3 Tall ²	Maestro 60/2 Tall ²	Maestro 75 ⁵	
Maestro 75XTU ²	Maestro 80/2 ³	Maestro 75 Tall ⁵	
Maestro 80/3 ³	Maestro 105/2 ³	Maestro 100 ⁵	
Maestro 105/3 ³	Metro 100XT/2 ¹		
Metro 100XT/3 ¹	Metro 130XT/2 ¹		
Metro 100XTL ¹			
Metro 100XTU ¹			
Metro 130XT/3 ¹			

¹ 100 mm, customised 90-200 mm

² 110 mm, customised 100-200 mm

³ 110 mm, customised 90-200 mm

⁴ 110 or 140 mm, customised 70-200 mm

⁵ 100 or 130 mm, customised 70-200 mm

⁶ 105 or 135 mm, customised 65-200 mm

full control and ultimate convenience



RCH remote control (DRU)

- extensive control functionality
- Honeywell controls



RCE remote control (DRU and DRU Global)

- straightforward control
- Mertik controls



Domotica Home Automation

- connection to various domotica systems
- for both Honeywell and Mertik controls

All remote controls feature electronic ignition, thermostat function and clock function.



App and control RCH fireplaces

New: the Bluetooth control system for DRU Eco Wave fireplaces. This ensures a fast and safe connection via the remote control or via the free downloadable DRU Fire app (IOS/Android). Very few fireplaces still have a WIFI connection, which requires a communication module.



Management module

Specifically for the recreation sector (holiday parks, hotels, etc.), DRU and ICY have developed a module to allow local control of fires and remote control by a reception system.

- Fitted with a motion and light sensor to ensure smart energy consumption
- Innovative and easy to use
- No separate remote control and no more batteries



Control hatch

When it comes to maintenance and faults, it is important to have access to the gas regulating block at all times. Which is why DRU has developed a special control hatch. This control hatch can be neatly integrated into the fire's set-up.

ventilation elements

Chimney breast ventilation to preserve your installation

Burning the fire generates heat in the chimney breast. In order to prevent cracking, it is important for the chimney breast to be ventilated. DRU has designed a variety of Lux elements for this purpose in ivory white and anthracite. These are integrated into the casing and can be fitted with mood lighting.

- ❶ Ivory white
- ❷ Anthracite



Lux Fino ❶ ❷



Lux Sleeve ❶



Lux Lignum ❶



Lux Omni ❶



Lux ❶

line drawings

Maestro 75XTU (p. 16)

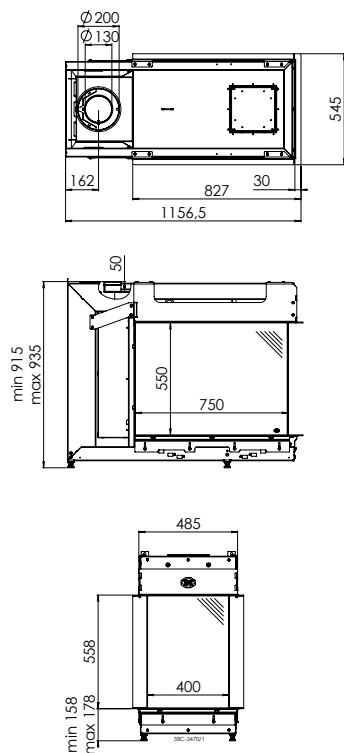

Maestro 60/3 (p. 18)

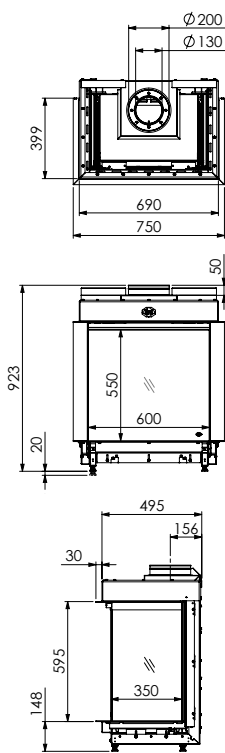

Maestro 60/3 Tall (p. 19)

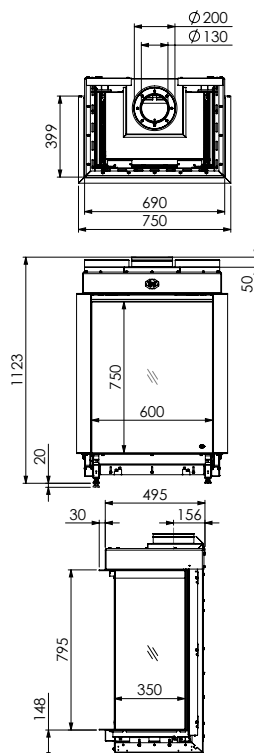

Maestro 80/3 (p. 20)

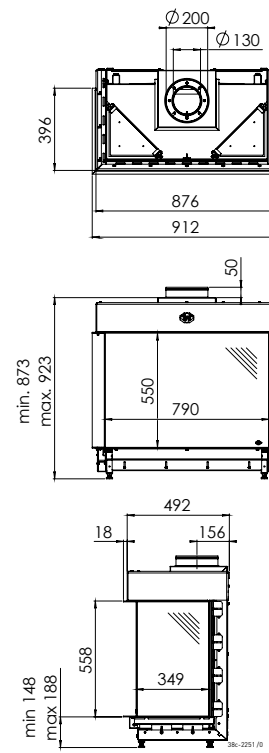

Maestro 105/3 (p. 21)

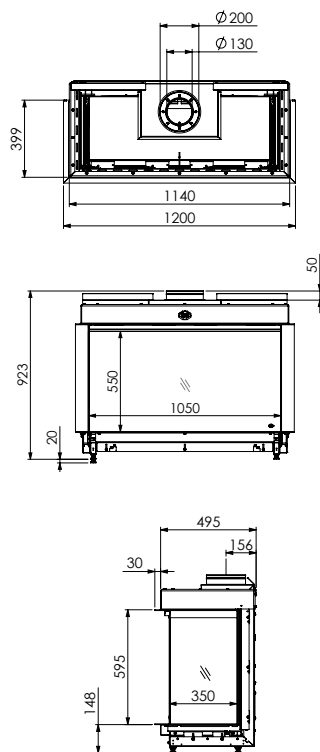

Maestro 60/2 (p. 22)

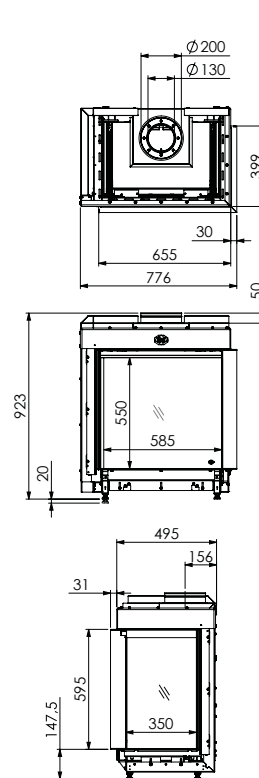

Maestro 60/2 Tall (p. 23)

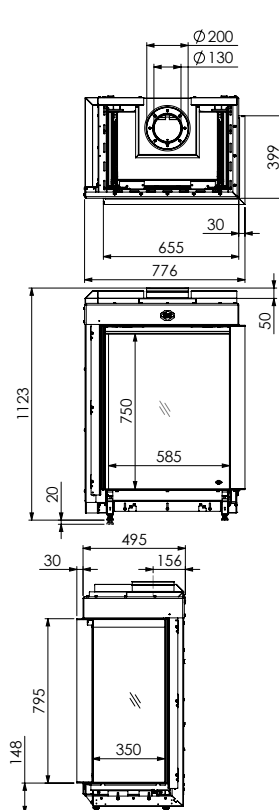

Maestro 80/2 (p. 24)

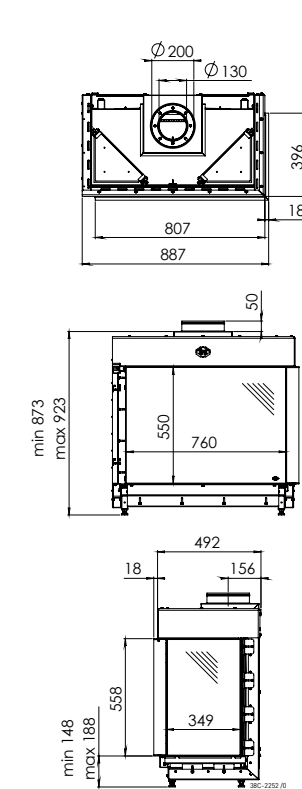

Maestro 105/2 (p. 25)

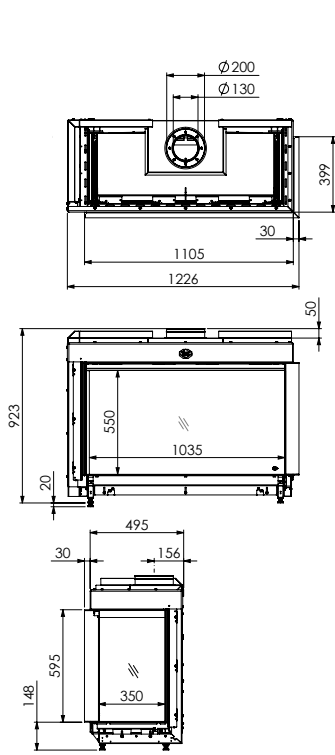

Maestro 60 (p. 26)

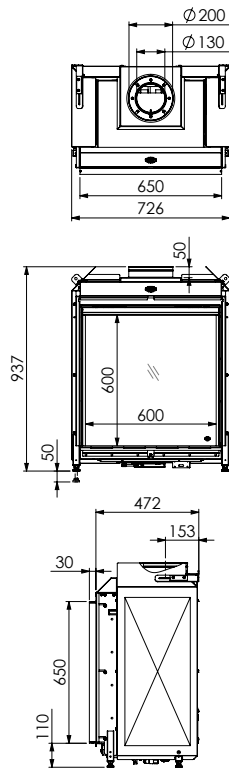

Maestro 60 Tall (p. 27)

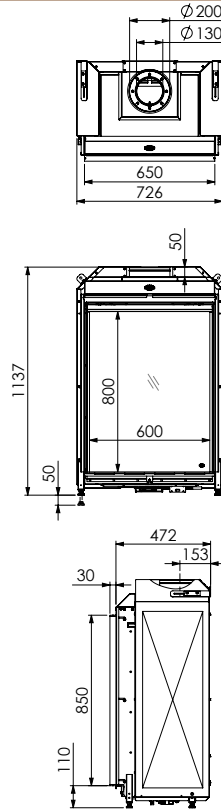

Maestro 75 | Tunnel (p. 28, 32)

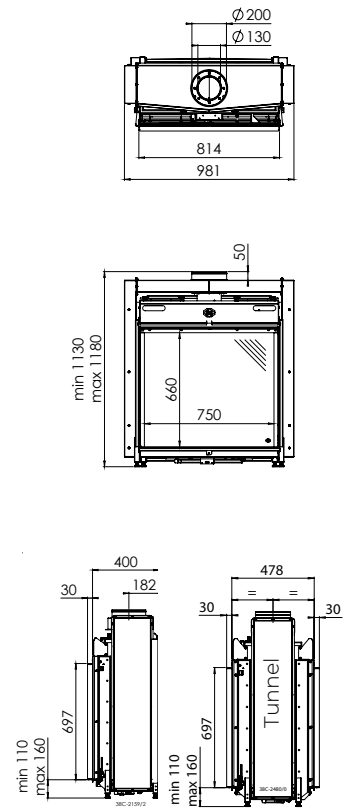

Maestro 75 Tall | Tunnel (p. 29, 33)

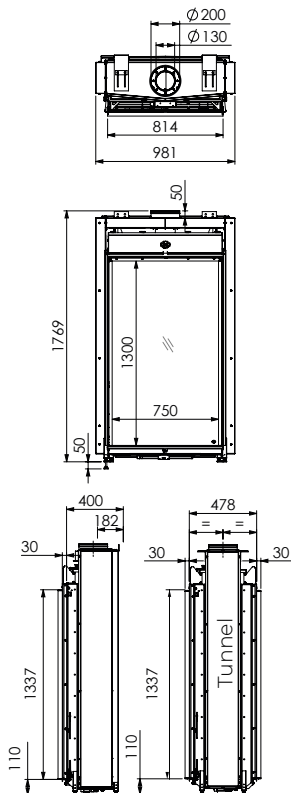

Maestro 100 (p. 30)

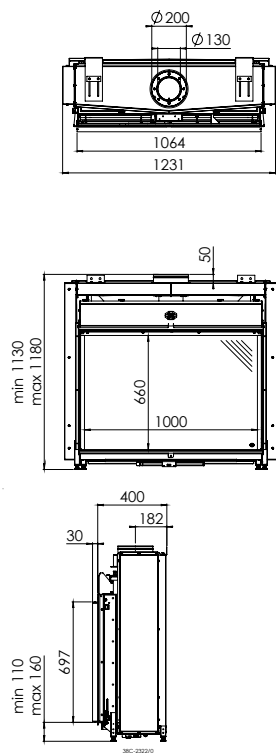

Metro 100XTU (p. 36)

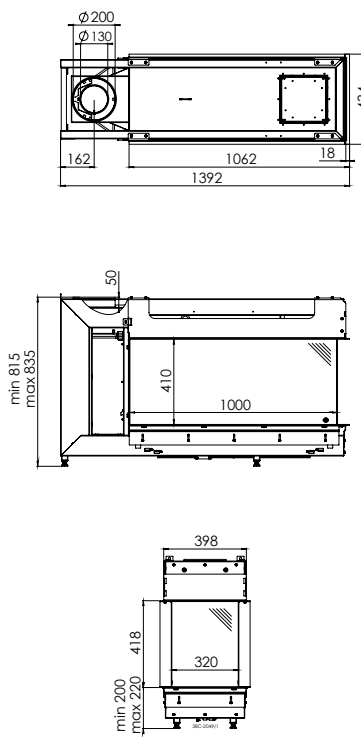

Metro 100XTL (p. 37)

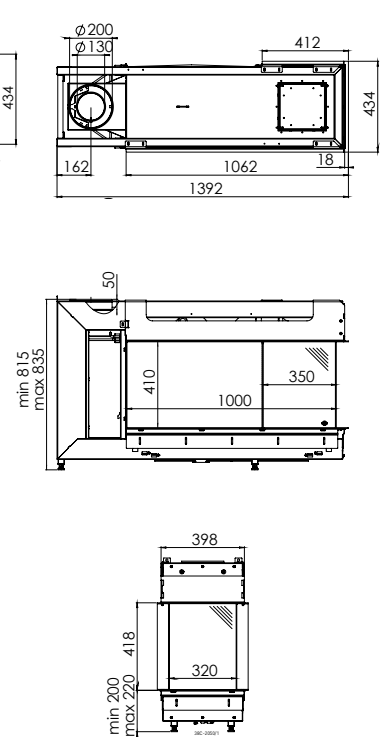

line drawings

Metro 130XTL (p. 37)

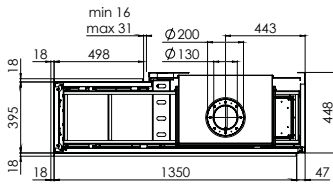

Metro 100XT/3 (p. 38)

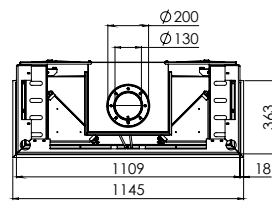

Metro 130XT/3 (p. 39)

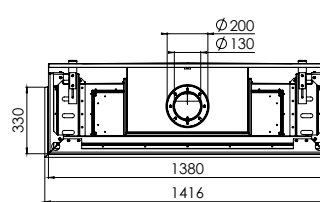

Metro 100XT/2 (p. 40)

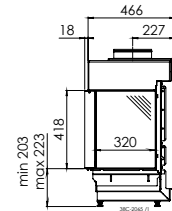
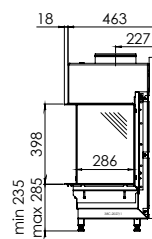
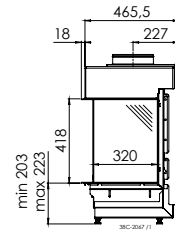
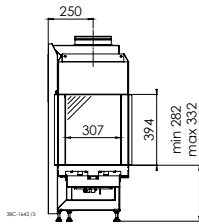
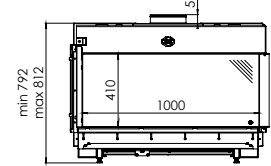
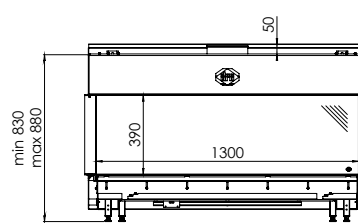
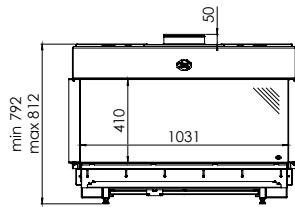
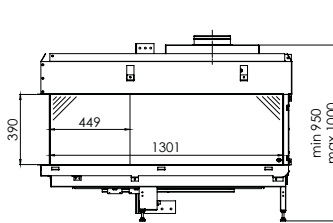
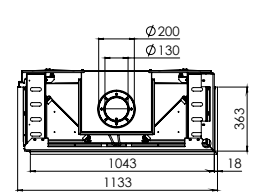

Metro 130XT/2 (p. 41)

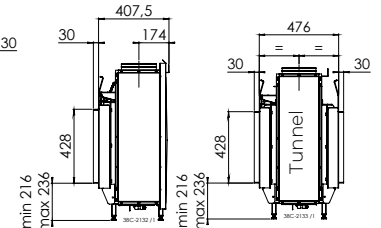
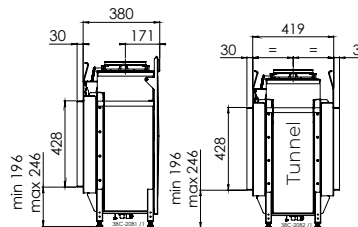
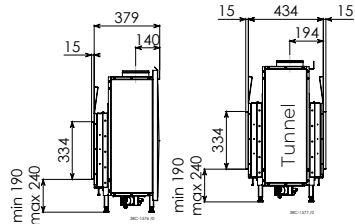
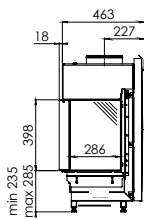
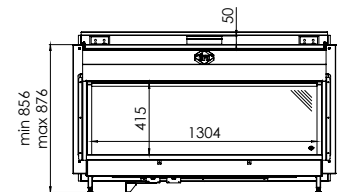
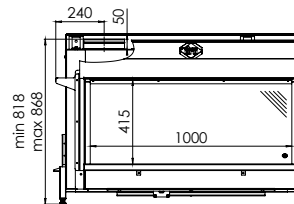
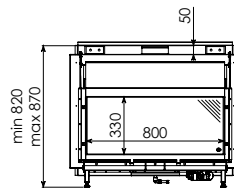
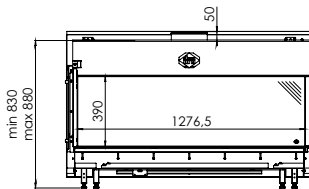
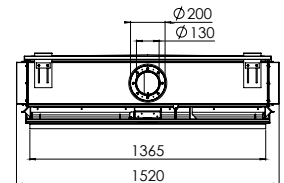
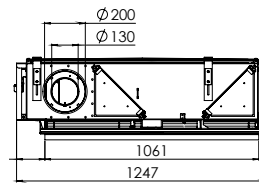
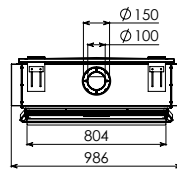
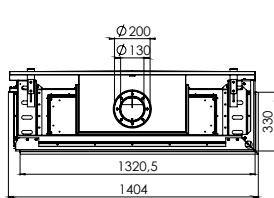

Metro 150XT | Tunnel (p. 44, 49)

Metro 200XT | Tunnel (p. 45, 49)

Lugo 70/3 (p. 52)

Lugo 80/3 (p. 52)

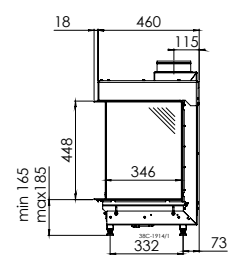
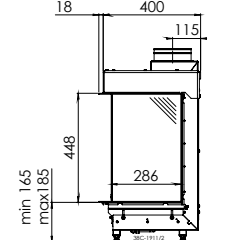
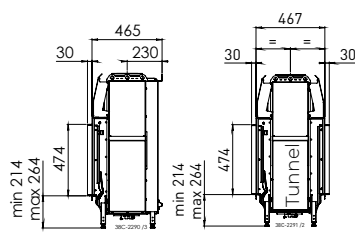
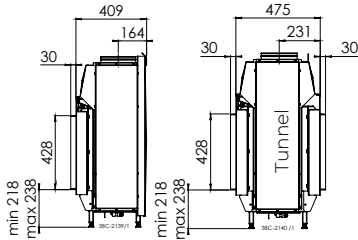
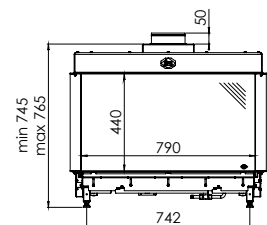
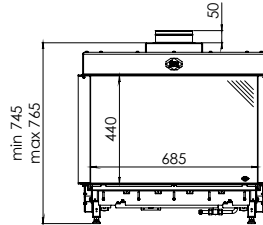
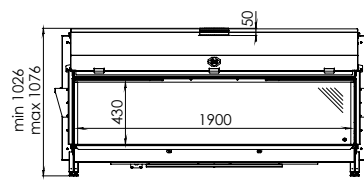
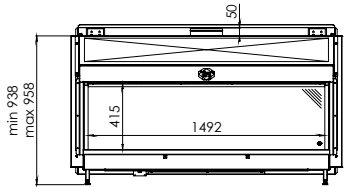
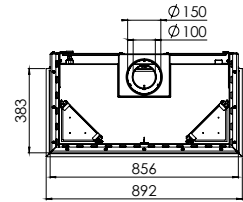
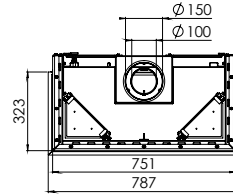
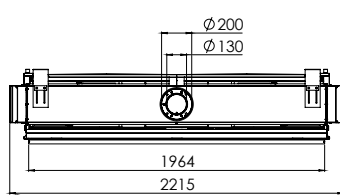
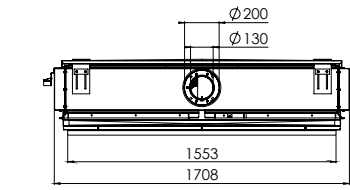

Lugo 70/2 (p. 53)

Lugo 80/2 (p. 53)

Cosmo | Tunnel (p. 56, 57)

Paco (p. 60)

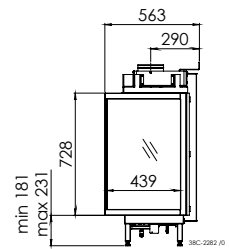
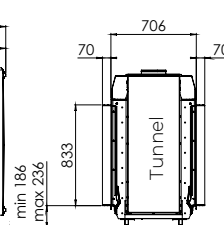
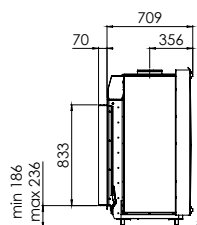
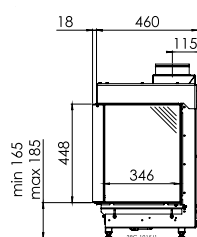
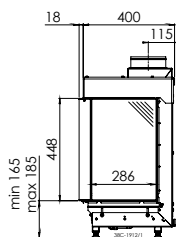
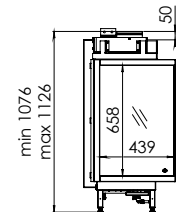
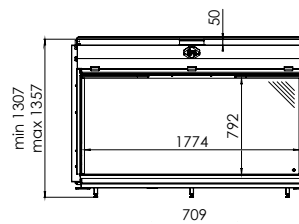
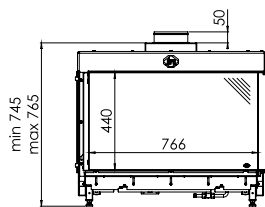
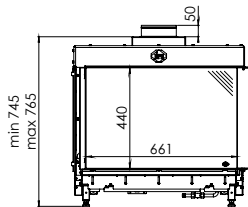
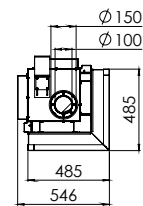
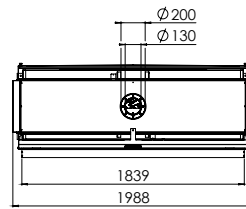
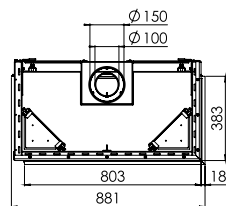
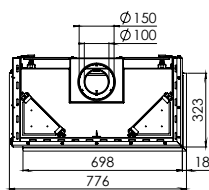

Global 100 Corner BF (p. 77)

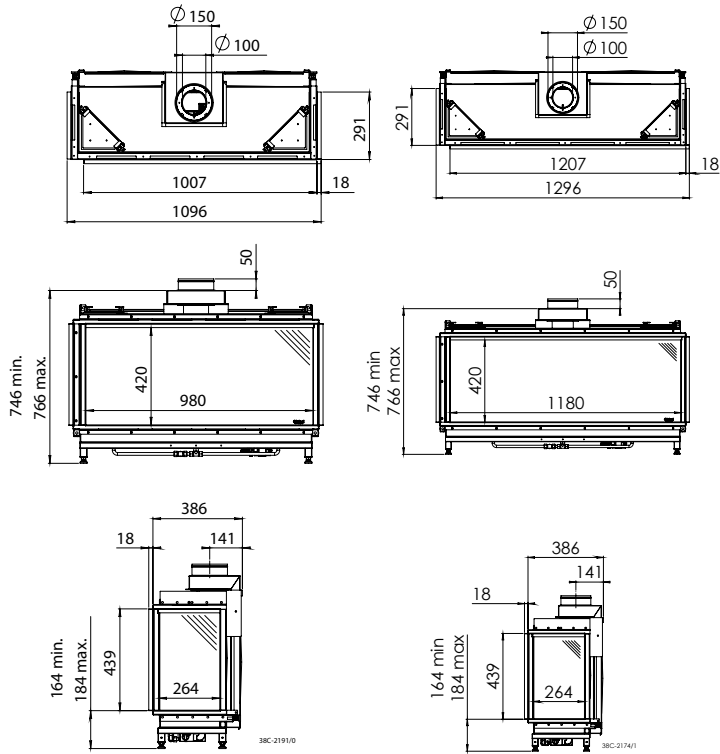

Global 120 Corner BF (p. 77)

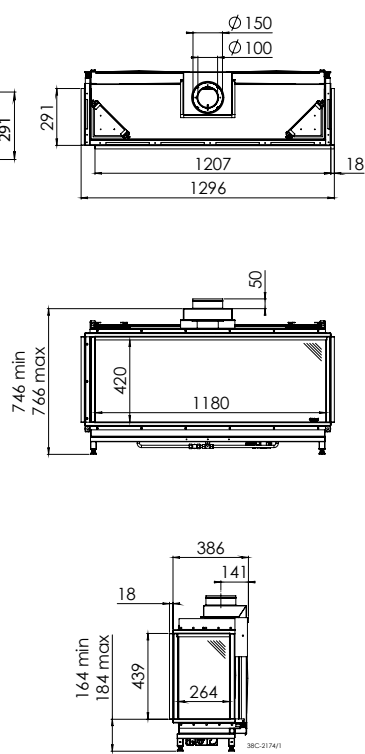

Global 55XT Cavity BF (p. 78)

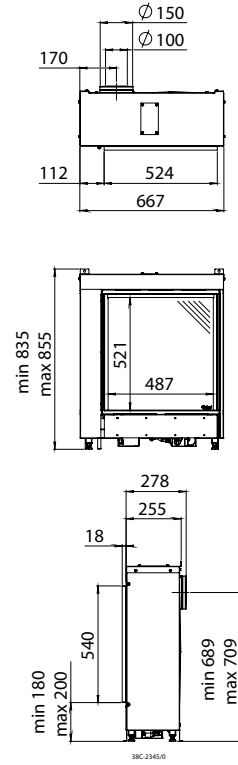

Global 55XT BF (p. 79)

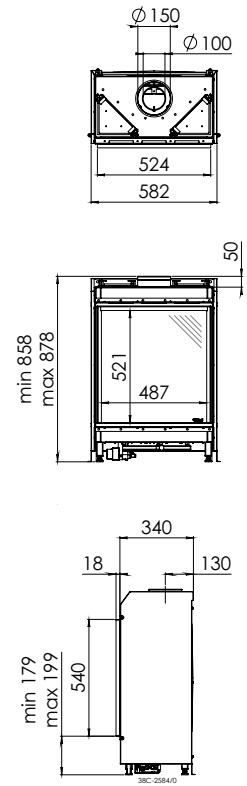

Global 70XT BF (p. 79)

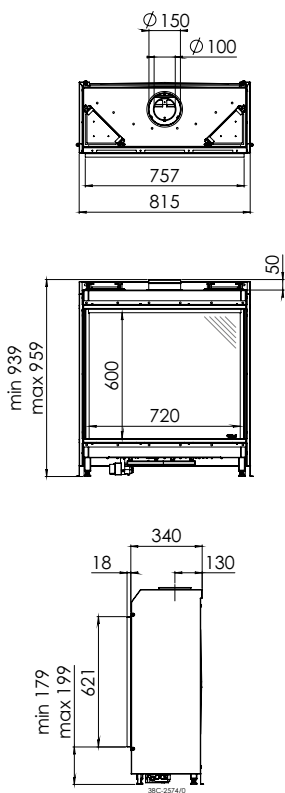

Global 100 BF | 120 BF (p. 80)

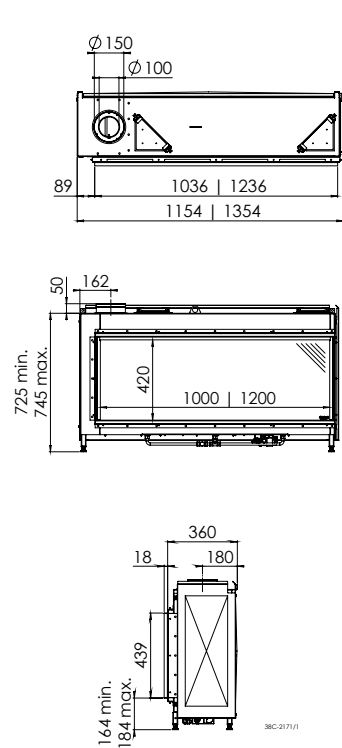

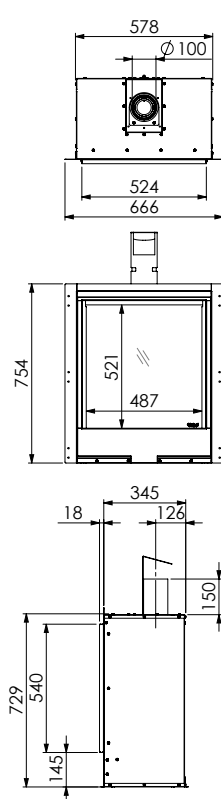

Global 55XT CF (p. 82)

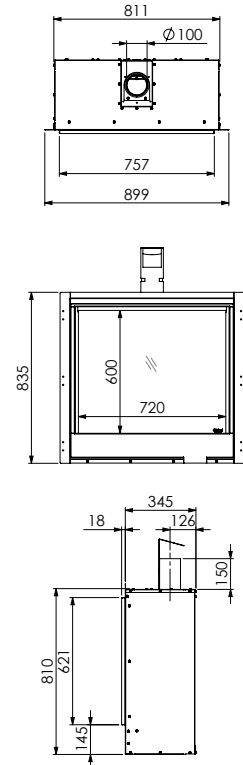

Global 70XT CF (p. 83)





technical specifications

	Page	Net output kW			Efficiency			Flue pipe Ø		Direct flue (p. 85)	Built-in depth	Control hatch (p. 88)		App (p. 88)		Remote control (p. 88)
		Natural gas G20	Natural gas G25.3 (NL)	Propane G31	(%) G20	Natural gas G20	Natural gas G25.3 (NL)					Propane G31	(mm)	bluetooth	wifi	
MAESTRO (closed combustion)																
Maestro 75XTU Eco Wave	16	1.2 - 8.8	1.2 - 8.4	1.9 - 9.5	93.3	A	A	A	200/130	+	545	+	+	-	-	+
Maestro 60/3 Eco Wave	18	1.9 - 7.2	1.6 - 6.8	1.1 - 7.3	94.3	A	A	A	200/130	+	495	+	+	-	-	+
Maestro 60/3 Tall Eco Wave	19	1.9 - 7.2	1.6 - 6.8	1.1 - 7.3	96.3	A	A	A	200/130	+	495	+	+	-	-	+
Maestro 80/3 Eco Wave	20	1.4 - 9.0	1.3 - 8.6	1.4 - 7.8	93.0	A	A	A	200/130	+	492	+	+	-	-	+
Maestro 105/3 Eco Wave	21	2.5 - 10.3	2.1 - 9.8	2.6 - 10.5	91.2	A	A	A	200/130	+	495	+	+	-	-	+
Maestro 60/2 Eco Wave	22	1.9 - 7.2	1.6 - 6.8	1.1 - 7.3	94.3	A	A	A	200/130	+	495	+	+	-	-	+
Maestro 60/2 Tall Eco Wave	23	1.9 - 7.2	1.6 - 6.8	1.1 - 7.3	96.3	A	A	A	200/130	+	495	+	+	-	-	+
Maestro 80/2 Eco Wave	24	1.4 - 9.0	1.3 - 8.6	1.4 - 7.8	93.0	A	A	A	200/130	+	492	+	+	-	-	+
Maestro 105/2 Eco Wave	25	2.5 - 10.3	2.1 - 9.8	2.6 - 10.5	91.2	A	A	A	200/130	+	495	+	+	-	-	+
Maestro 60 Eco Wave	26	1.9 - 7.2	1.6 - 6.8	1.1 - 7.3	94.3	A	A	A	200/130	+	472	+	+	-	-	+
Maestro 60 Tall Eco Wave	27	1.9 - 7.2	1.6 - 6.8	1.1 - 7.3	96.3	A	A	A	200/130	+	472	+	+	-	-	+
Maestro 75 Eco Wave	28	1.3 - 9.0	1.2 - 8.6	1.3 - 7.4	89.0	A	A	A	200/130	+	400	+	+	-	-	+
Maestro 75 Tall Eco Wave	29	1.7 - 9.2	1.5 - 8.7	1.5 - 8.2	91.6	A	A	A	200/130	+	400	+	+	-	-	+
Maestro 100 Eco Wave	30	2.3 - 10.0	1.9 - 9.3	2.3 - 10.2	92.1	A	A	A	200/130	+	400	+	+	-	-	+
Maestro 75 Tunnel Eco Wave	32	1.7 - 9.1	1.5 - 8.5	1.9 - 9.5	93.0	A	A	A	200/130	+	478	+	+	-	-	+
Maestro 75 Tunnel Tall Eco Wave	33	2.0 - 10.2	1.7 - 9.5	2.0 - 10.0	92.0	A	A	A	200/130	+	478	+	+	-	-	+
METRO (closed combustion)																
Metro 100XTU Eco Wave	36	4.3 - 9.6	3.3 - 9.0	4.1 - 9.1	83.3	B	B	B	200/130	+	434	+	-	+	-	+
Metro 100XTL Eco Wave	37	4.3 - 9.6	3.3 - 9.0	4.1 - 9.1	83.3	B	B	B	200/130	+	434	+	-	+	-	+
Metro 130XTL Eco Wave	37	5.1 - 10.8	4.1 - 10.2	5.6 - 10.6	89.6	A	A	A	200/130	+	448	+	-	+	-	+
Metro 100XT/3 Eco Wave	38	4.3 - 9.6	3.3 - 9.0	4.1 - 9.1	83.3	B	B	B	200/130	+	466	+	-	+	-	+
Metro 130XT/3 Eco Wave	39	5.1 - 10.8	4.1 - 10.2	5.6 - 10.6	89.6	A	A	A	200/130	-	463	+	-	+	-	+
Metro 100XT/2 Eco Wave	40	4.3 - 9.6	3.3 - 9.0	4.1 - 9.1	83.3	B	B	B	200/130	+	466	+	-	+	-	+
Metro 130XT/2 Eco Wave	41	5.1 - 10.8	4.1 - 10.2	5.6 - 10.6	89.6	A	A	A	200/130	+	466	+	-	+	-	+
Metro 80XT Eco Wave	42	3.0 - 5.4	2.3 - 5.1	2.8 - 5.7	88.9	A	B	A	150/100	-	379	+	+	-	-	+
Metro 100XT Eco Wave	43	4.3 - 9.6	3.3 - 9.0	4.1 - 9.1	83.3	B	B	B	200/130	+	380	+	-	+	-	+
Metro 130XT Eco Wave	44	5.1 - 10.8	4.1 - 10.2	5.6 - 10.6	89.6	A	A	A	200/130	-	408	+	-	+	-	+
Metro 150XT Eco Wave	44	5.9 - 10.8	4.9 - 10.3	5.3 - 11.1	87.9	A	A	A	200/130	-	409	+	-	+	-	+
Metro 200XT Eco Wave	45	8.9 - 16.7	7.2 - 15.8	7.3 - 15.4 ¹⁾	90.3	A	A	A	200/130	-	465	+	-	+	-	+
Metro 80XT Tunnel Eco Wave	46	3.0 - 5.4	2.3 - 5.1	2.8 - 5.7	88.9	A	B	A	150/100	-	434	+	+	-	-	+
Metro 100XT Tunnel Eco Wave	47	4.3 - 9.6	3.3 - 9.0	4.1 - 9.1	83.3	B	B	B	200/130	+	419	+	-	+	-	+
Metro 130XT Tunnel Eco Wave	48	5.1 - 10.8	4.1 - 10.2	5.6 - 10.6	89.6	A	A	A	200/130	-	476	+	-	+	-	+
Metro 150XT Tunnel Eco Wave	49	5.9 - 10.8	4.9 - 10.3	5.3 - 11.1	87.9	A	A	A	200/130	-	475	+	-	+	-	+
Metro 200XT Tunnel Eco Wave	49	8.9 - 16.7	7.2 - 15.8	7.3 - 15.4 ¹⁾	90.3	A	A	A	200/130	-	467	+	-	+	-	+

¹⁾ Propane only in combination with Powervent®

(kg)	Weight	Eco Wave (p. 7)	Eco Glow (p. 7)	Easy release door system (p. 11)	PowerVent® (p. 84)	Clear View glass (p. 10)	Interior/internal finish (p. 8)	Black	Cera-glass	Matt glass	Rib cast	Classic stone	Rib cast	Type	Log set brown	Log set white	Stones white	Stones grey	Glass anthracite
	ECO	☀️	🚪	PV+	🖼️	Wall panel (p. 9)	Burner												
172	+	+	-	+	+	+	+	+	-	-	-	-	-	Dynamic Flame Burner®	+	-	-	-	-
130	+	+	+	+	+	+	+	+	-	-	-	-	-	Dynamic Flame Burner®	+	-	-	-	-
140	+	+	+	+	-	+	+	+	-	-	-	-	-	Dynamic Flame Burner®	+	-	-	-	-
116	+	+	-	+	+	+	+	+	-	+	-	+	+	Dynamic Flame Burner®	+	-	-	-	-
183	+	+	+	+	+	+	+	+	-	+	-	+	+	Dynamic Flame Burner®	+	-	-	-	-
130	+	+	+	+	+	+	+	+	-	-	-	-	-	Dynamic Flame Burner®	+	-	-	-	-
140	+	+	+	+	-	+	+	+	-	-	-	-	-	Dynamic Flame Burner®	+	-	-	-	-
116	+	+	-	+	+	+	+	+	-	+	-	+	+	Dynamic Flame Burner®	+	-	-	-	-
183	+	+	+	+	+	+	+	+	-	+	-	+	+	Dynamic Flame Burner®	+	-	-	-	-
125	+	+	+	+	+	+	+	+	-	-	+	-	-	Dynamic Flame Burner®	+	-	-	-	-
132	+	+	+	+	+	+	+	+	+	-	-	-	-	Dynamic Flame Burner®	+	-	-	-	-
140	+	+	+	+	+	+	+	+	-	+	+	+	+	Dynamic Flame Burner®	+	-	-	-	-
218	+	+	+	+	+	-	+	+	-	-	-	-	-	Dynamic Flame Burner®	+	-	-	-	-
184	+	+	+	+	+	+	+	+	-	+	+	+	+	Dynamic Flame Burner®	+	-	-	-	-
160	+	+	+	+	+	+	+	-	-	-	-	-	-	Dynamic Flame Burner®	+	-	-	-	-
218	+	+	+	+	+	-	+	+	-	-	-	-	-	Dynamic Flame Burner®	+	-	-	-	-
139	+	-	-	+	+	+	+	+	-	-	-	-	-	Vario Burner	+	-	+	-	+
139	+	-	-	+	+	+	+	+	-	-	-	-	-	Vario Burner	+	-	+	-	+
165	+	-	-	+	+	+	+	+	-	-	-	-	-	Vario Burner	+	+	+	+	-
126	+	-	-	+	+	+	+	+	-	-	-	-	-	Vario Burner	+	-	+	-	+
159	+	-	-	+	+	+	+	+	-	-	-	-	-	Vario Burner	+	+	+	+	-
132	+	-	-	+	+	+	+	+	-	-	-	-	-	Vario Burner	+	-	+	-	+
163	+	-	-	+	+	+	+	+	-	-	-	-	-	Vario Burner	+	+	+	+	-
97	+	-	-	+	+	+	+	+	-	-	-	-	-	Vario Burner	+	-	+	-	-
138	+	-	+	+	+	+	+	+	-	-	-	-	-	Vario Burner	+	-	+	-	+
163	+	-	+	+	+	+	+	+	-	-	-	-	-	Vario Burner	+	+	+	+	-
161	+	-	+	+	+	-	+	+	-	-	-	-	-	Vario Burner	+	+	+	+	-
265	+	-	+	+	+	-	+	+	-	-	-	-	-	Vario Burner	+	-	+	-	+
96	+	-	-	+	+	+	+	+	-	-	-	-	-	Vario Burner	+	-	+	-	-
136	+	-	+	+	+	+	+	+	-	-	-	-	-	Vario Burner	+	-	+	-	+
165	+	-	+	+	+	+	+	+	-	-	-	-	-	Vario Burner	+	+	+	+	-
159	+	-	+	+	+	+	+	+	-	-	-	-	-	Vario Burner	+	+	+	+	-
265	+	-	+	+	+	+	+	+	-	-	-	-	-	Vario Burner	+	-	+	-	+

technical specifications

	Page	Net output kW			Efficiency				Flue pipe Ø (mm)		Direct flue (p. 85) (mm)	Built-in depth	Control hatch (p. 88)		App (p. 88)		Remote control (p. 88)
		Natural gas G20	Natural gas G25.3 (NL)	Propane G31	(%) G20	Natural gas G20	Natural gas G25.3 (NL)	Propane G31					bluetooth	wifi	RCE	RCH	
LUGO (closed combustion)																	
Lugo 70/3 Eco Wave	52	3.4 - 6.9	2.8 - 6.5	3.2 - 6.3	91.0	A	A	A	150/100	-	400	-	+	-	-	-	+
Lugo 80/3 Eco Wave	52	3.4 - 6.9	2.8 - 6.5	3.2 - 6.3	91.0	A	A	A	150/100	-	460	-	+	-	-	-	+
Lugo 70/2 Eco Wave	53	3.4 - 6.9	2.8 - 6.5	3.2 - 6.3	91.0	A	A	A	150/100	-	400	-	+	-	-	-	+
Lugo 80/2 Eco Wave	53	3.4 - 6.9	2.8 - 6.5	3.2 - 6.3	91.0	A	A	A	150/100	-	460	-	+	-	-	-	+
COSMO (closed combustion)																	
Cosmo Eco Wave	56	6.0 - 16.3	4.9 - 15.7	-	89.3	A	A	-	200/130	-	709	+	+	-	-	-	+
Cosmo Tunnel Eco Wave	57	6.0 - 16.3	4.9 - 15.7	-	89.3	A	A	-	200/130	-	706	+	+	-	-	-	+
PACO (closed combustion)																	
Paco Eco Wave	60	2.6 - 5.4	2.1 - 5.0	-	84.8	B	C	-	150/100	-	563	+	+	-	-	-	+
FREE-STANDING (closed combustion)																	
Maestro 60/3 Module Eco Wave	64	1.9 - 7.2	1,6 - 6,8	1,1 - 7,3	94,3	A	A	A	200/130	+	581	-	+	-	-	-	+
Convexo Eco Wave	65	2,6 - 5,0	2,1 - 4,7	2,6 - 5,0	92,4	A	A	A	150/100	-	427	-	+	-	-	-	+
Passo Eco Wave	66	1,2 - 6,4	0,9 - 6,1	-	93,0	A	A	-	150/100	-	452	-	+	-	-	-	+
Polo	68	1,6 - 4,1	1,5 - 3,8	1,6 - 3,8	92,6	A	A	A	150/100	-	400	-	-	-	-	+	-
Diablo Next	69	1,6 - 4,1	1,5 - 3,8	1,6 - 3,8	92,6	A	A	A	150/100	-	372	-	-	-	-	+	-
Circo	70	2,9 - 7,0	2,7 - 6,0	2,8 - 6,2	92,5	A	A	A	150/100	-	442	-	-	-	-	+	-
Trio Black Edition	71	2,0 - 4,5	1,8 - 4,2	1,5 - 4,0	85,4	B	B	C	150/100	-	441	-	-	-	-	+	-
GLOBAL (closed combustion)																	
Global 100 Triple BF	75	2.8 - 7.5	2.6 - 7.1	3.5 - 7.0	94.0	A	A	A	150/100	+	386	-	-	-	-	+	-
Global 120 Triple BF	75	2.8 - 7.5	2.6 - 7.1	3.5 - 7.0	94.0	A	A	A	150/100	+	386	-	-	-	-	+	-
Global 60 Corner BF	76	2.3 - 6.0	2.1 - 5.4	3.0 - 6.2	91.5	A	A	A	150/100	+	325	-	-	-	-	+	-
Global 100 Corner BF	77	2.8 - 7.5	2.6 - 7.1	3.5 - 7.0	94.0	A	A	A	150/100	+	386	-	-	-	-	+	-
Global 120 Corner BF	77	2.8 - 7.5	2.6 - 7.1	3.5 - 7.0	94.0	A	A	A	150/100	+	386	-	-	-	-	+	-
Global 55XT Cavity BF (UK only)	78	1.8 - 3.2	-	-	77.4	C	-	-	150/100	-	255	-	-	-	-	+	-
Global 55XT BF	79	2.6 - 4.6	2.4 - 4.3	3.1 - 4.4	92.6	A	A	A	150/100	+	340	-	-	-	-	+	-
Global 70XT BF	79	3.4 - 5.7	3.1 - 5.3	3.2 - 5.5	92.7	A	A	A	150/100	+	340	-	-	-	-	+	-
Global 100 BF	80	2.8 - 7.5	2.6 - 7.1	3.5 - 7.0	94.0	A	A	A	150/100	+	360	-	-	-	-	+	-
Global 120 BF	80	2.8 - 7.5	2.6 - 7.1	3.5 - 7.0	94.0	A	A	A	150/100	+	360	-	-	-	-	+	-
GLOBAL (open combustion)																	
Global 55XT CF	82	2.8 - 3.7	2.6 - 3.5	-	74.4	D	D	-	100	-	345	-	-	-	-	+	-
Global 70XT CF	83	3.1 - 4.5	2.7 - 4.4	4.0 - 4.6	77.1	C	D	D	100	-	345	-	-	-	-	+	-

The flame pictures produced by the fires will differ according to the fuel used.

(kg)	Weight	Eco Wave (p. 7)	Eco Glow (p. 7)	Easy release door system (p. 11)	PowerVent® (p. 84)	Clear View glass (p. 10)	Interior/internal finish (p. 8)	Black	Cera-glass	Matt glass	Rib cast	Classic stone	Rib cast	Wall panel (p. 9)	Burner	Burner bed	Log set brown	Log set white	Stones white	Stones grey	Glass anthracite
87	+	-	-	+	-	+	+	-	-	-	-	-	-	Vario Burner	+	-	-	-	-	-	-
95	+	-	-	+	-	+	+	-	-	-	-	-	-	Vario Burner	+	-	-	-	-	-	-
86	+	-	-	+	-	+	+	-	-	-	-	-	-	Vario Burner	+	-	-	-	-	-	-
95	+	-	-	+	-	+	+	-	-	-	-	-	-	Vario Burner	+	-	-	-	-	-	-
394	+	-	+	+	+	+	-	-	-	-	-	-	-	Vario Burner	+	-	-	-	-	-	-
327	+	-	+	+	+	+	-	-	-	-	-	-	-	Vario Burner	+	-	-	-	-	-	-
72	+	-	-	+	-	-	+	-	-	-	-	-	-	Line Burner	+	-	-	-	-	-	-
200	+	+	+	-	+	+	+	-	-	-	-	-	-	Dynamic Flame Burner®	+	-	-	-	-	-	-
104	+	+	+	-	-	+	+	-	-	-	-	-	-	Dynamic Flame Burner®	+	-	-	-	-	-	-
95	+	-	+	-	-	+	-	-	-	-	-	-	-	Dynamic Flame Burner®	+	-	-	-	-	-	-
68	-	-	-	-	-	+	+	-	-	-	-	-	-	Line Burner	+	-	-	-	-	-	-
48	-	-	-	-	-	+	+	-	-	-	-	-	-	Line Burner	+	-	-	-	-	-	-
91	-	-	-	-	-	+	-	-	-	-	-	-	-	Line Burner	+	-	-	-	-	-	-
81	-	-	-	-	-	-	+	-	-	-	-	-	-	Line Burner	+	-	-	-	-	-	-
90	-	-	-	-	-	+	+	-	-	-	-	-	-	Line Burner	+	-	+	-	-	+	+
95	-	-	-	-	-	+	+	-	-	-	-	-	-	Line Burner	+	-	+	-	-	+	+
69	-	-	-	-	-	+	+	-	-	-	-	-	-	Line Burner	+	-	-	-	-	-	-
90	-	-	-	-	-	+	+	-	-	-	-	-	-	Line Burner	+	-	-	-	-	-	-
95	-	-	-	-	-	+	+	-	-	-	-	-	-	Line Burner	+	-	+	-	-	-	+
50	-	-	-	-	+	-	+	-	-	-	-	-	-	Truflame Burner®	+	-	-	-	-	-	-
90	-	-	-	-	+	+	+	-	-	+	-	-	-	Truflame Burner®	+	-	-	-	-	-	-
103	-	-	-	-	+	+	+	-	-	+	-	-	-	Truflame Burner®	+	-	-	-	-	-	-
94	-	-	-	-	-	+	+	-	-	-	-	-	-	Line Burner	+	-	+	-	-	+	+
103	-	-	-	-	-	+	+	-	-	-	-	-	-	Line Burner	+	-	+	-	-	+	+
70	-	-	-	-	+	+	+	-	-	+	-	-	-	Truflame Burner®	+	-	-	-	-	-	-
101	-	-	-	-	+	+	+	-	-	+	-	-	-	Truflame Burner®	+	-	-	-	-	-	-

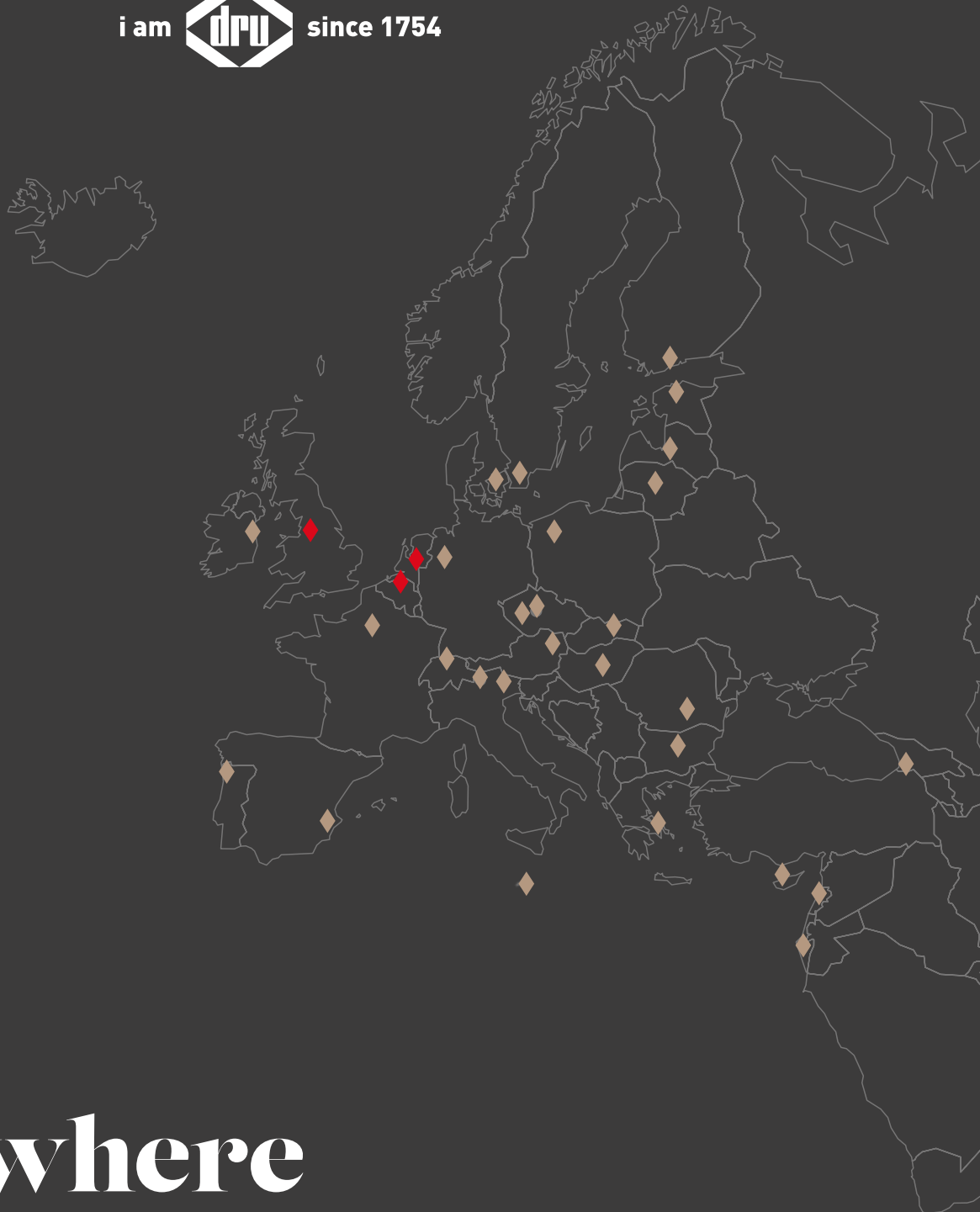

i am everywhere

DRU Verwarming B.V.
PO Box 1021 | 6920 BA Duiven
Ratio 8 | 6921 RW Duiven
The Netherlands
T. +31 (0)26 - 319 5 319
www.dru.nl

Drugasar Ltd.
Deans Road | Swinton
Manchester | M27 0JH
United Kingdom
T. +44 (0)161 - 793 8700
www.drufire.co.uk

DRU Belgium
Kontichsesteenweg 69/1
2630 Aartselaar
Belgium
T. +32 (0)3 - 450 7000
www.drufire.be



www.drufire.com



BY APPOINTMENT OF
THE COURT OF THE NETHERLANDS



Art-993400 | 2023-10

DRU: Member of the Spartherm-Group

Subject to changes. The colours, appearance and flame pictures in this brochure may differ from reality.
Nothing in this publication may be used without prior written consent from DRU Verwarming B.V.

SOCIAL MEDIA :

For further inspiration and information, please see one of our social media channels or scan the QR code

